

OSCULATI



**NEWS SEPTEMBER
2023**

GHOST II HIDDEN CLEAT

*Black
Line*



Black Line version of the Ghost II hidden watertight cleat.

Made of AISI 316 stainless steel, it guarantees maximum smoothness thanks to the fluorinated rubber O-rings and the ergonomic grip.

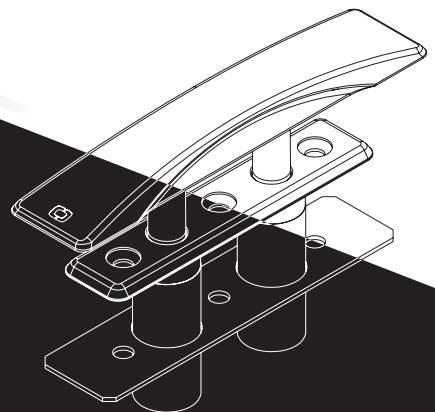

IDENTITY

Osculati is the leading company in Italy and one among the most important companies in Europe in the marine accessory market, a safe and reliable reference point for professionals and pleasure boaters.

The company, founded in 1958 as the first marine accessory retailer in Milan, has turned into an international company and exclusive and official partner of some of the major shipyards in the world.

The third generation of the family, Alberto, Giorgio and Claudia Osculati is proud to support the Chairman Mario Osculati in the management of the company, with the help of the partners Francesco and Alessandro Gambogi.

Osculati's products can be found in thousands of shops and shipyards in 100 countries. The company has developed a professional sales force worldwide, with a turnover of € 118 million in 2022, more than 166 direct employees for a total available area of 21,000 sq.m.



OUR NUMBERS



17,5

tons of goods we deliver every day



100

number of countries regularly supplied with our goods



22.000

products on our Master Catalogue



7.000

Osculati trademark products



166

direct employees



42.000.000 €

value of goods in our stock



96%

goods availability



1.000

new entries in our catalogue every year



21.000 mq

overall storage area



6.000

dealers worldwide

▲ DESIGN & ENGINEERING

The product development process often starts thanks to the innovative addition that has always characterized the Osculati family and the Chairman Mario Osculati in particular.

Inputs and suggestions from our customers, mainly shipyards, as well as from the sailors and boaters that work with us, trigger a process of constant development to create new solutions that fully meet any requirements.

Over 7000 articles developed by the company's Design & Engineering department where a team of engineers and designers is dedicated to the in-house development of CAD models and the implementation of prototypes and samples by means of 3D printers.

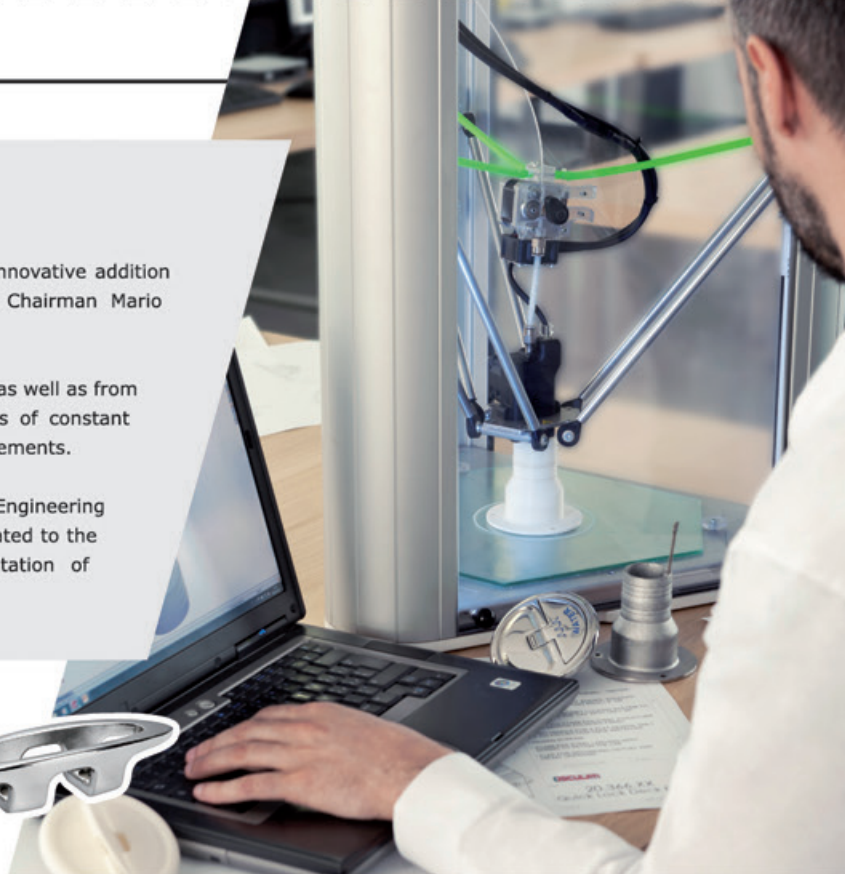

▲ QUALITY CONTROL

Our Integrated Quality Management Team consists of 5 internal inspectors who daily put products through different levels of quality tests according to their market category.

Our salt spray chamber and UV-chamber test both accelerated ageing due to tough marine environment and damage caused by sunlight. Our in-house lab also tests all new products before they are placed on the market in order to offer increasingly higher quality standards.

We work with the best-known labs and institutions to perform accurate IP water-resistance tests, electrical tests as well as breaking loads tests.

- Over 65,000 annual tests
- 50 product certifications every year.
- Over 5,000 hours of salt spray chamber tests per year
- Over 1,000 hours of UV-chamber tests per year



▲ PRODUCTS TAILORED FOR THE SHIPYARDS

Thanks to our new laser printer the items on our catalogue can be tailored by engraving logo and name.

On demand we also make products that meet specific needs in order to develop the best solutions as for design and efficiency:

- Stainless steel items designed ex-novo by the specific needs of the customer.
- Plastic tanks (for freshwater, black water, diesel and petrol) tailored to the boat spaces.
- Hatches in the desired RAL colours.

We also take care of the type testing procedures and the documents needed.



▲ IN-HOUSE PRODUCTION

An in-house production, assembly and packaging department where by 30 specialised workers produce lights, ladders, gangways, battery switches and many other products.

This allows us the highest production process control by an ongoing monitoring of all production steps, production time reduction and flexibility to meet our customers' requirements.

Moreover thanks to a short supply chain we can be more competitive on the market.



▲ LOGISTICS

Our marine equipment warehouse is the largest in Europe and one of the best-stocked worldwide offering over 22,000 items and goods availability exceeding 96%.

21,000 square metres, 42-million Euros worth goods in our depots, 17 tons of marine equipment shipped every day: these are the figures of Osculati's logistics.

We pursue innovation and technological upgrading. As of January 2022, a new semi-automized area will be implemented where over 40% of the orders in progress will be dealt with aimed at offering our customers an increasingly faster and better service.

This flood of items is managed by 75 qualified warehouse and 55 logistics operators staff who work every day to offer the best standards in terms of efficiency, speed and safety during the preparation and shipment of goods to customers.

70% of the orders coming from the European Union is shipped on the same day while the remaining 25% is shipped the day after their reception.



Osculati has always worked alongside organisations and associations committed to achieving the 2030 Agenda goals, both through its financial contributions and by providing its expertise.

 Project for People



 **BARCO HOSPITAL SAN RAFFAELE**
FUNDACION ITALOCOLOMBIANA DEL MONTE TAMBORA



Osculati has chosen to offset emissions from its transport vehicles by adhering to the Blue Valley project.

By means of the project, Osculati has offset 83 tonnes of CO₂ emissions in 2022.

For more than ten years Osculati has been using exclusively 100% carbon offset renewable energy, while its logistics warehouse is powered by a geothermal and solar energy system.

 **Blue Valley**
bio fish & carbon credits



*There's much more
to read!*



**Download our
Sustainability Report**



Bow roller + Trefoil[®] anchor

With wave guard system.
High-level products for style and performance.



OSCOLATI



Bow roller + Trefoil[®] anchor with anti-water plate

AISI 316

SELF LAUNCHING

Bow roller fitted with an anchor having a coupling plate that closes perfectly the hole on the hull. This system makes the plate strike against the roller preventing water from leaking into the forepeak. The roller is designed to match the Trefoil anchor for a combination of high-level products in style and performance.

The system can be easily installed by 4 studs behind the roller and is fitted with two sheaves for smooth sliding of the chain.

Made from 100% mirror-polished AISI316 stainless steel.

It is recommended to install it on the chain by means of the Twist joint 01.738.01.

Windlass ideal pull angle at 5° / 20° from the roller horizontal axis.

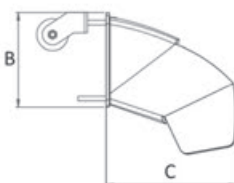
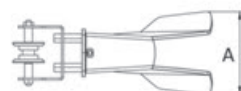
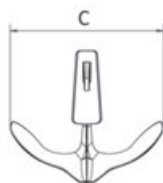
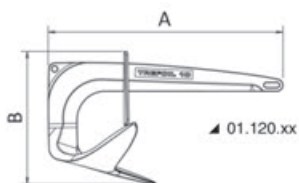

Code	Description	kg	mm			
			A	B	C	D
01.120.07	New Trefoil anchor 7.5 kg	7.5	535	230	352	-
01.120.10	Trefoil anchor 10 kg	10	588	331	383	-
01.120.20	New Trefoil anchor 20 kg	20	702	370	468	-
01.121.07	New Bow roller 7.5 kg	6.3	150	168	232	322
01.121.10	Bow roller 10 kg	9.3	117	203	279	305
01.121.20	New Bow roller 20 kg	12.6	206	224	270	254

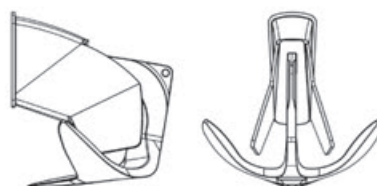

3D AVAILABLE



video

Mr. Fantastic extendable roller

Ideal for vertical bow.
From 7,5 to 30 kg anchor.



Mr. Fantastic extendable roller

EXTENDABLE

IDEAL FOR VERTICAL BOW

SELF LAUNCHING

Made of mirror-polished stainless steel, ideal for Trefoil or similar anchors.
Fitted with an innovative gas spring system that keeps the anchor off the bow before being cast.

At the same time, a tilting movement lets the anchor drop automatically while keeping it at a safety distance from the bow.

The roller has a **22-cm extension stroke** and is mainly suitable for vertical bows.

Its lightweight and sports shape is well-suited to the hull and its steel frame is designed to withstand high loads.

OSCOLATI



video



extensible

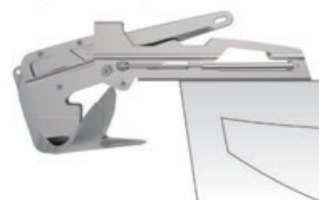

self launching



Code	For anchors kg	Extension mm	A mm	B mm	C mm	D mm	Ø mm	Plate thickness mm
01.338.07	7.5 - 10	130	468	357	120	228	8.4	5
01.338.15	10 - 15	200	625	480	120	270	10.4	5
01.338.30 New	20 - 30	220	750	600	140	310	10.4	8

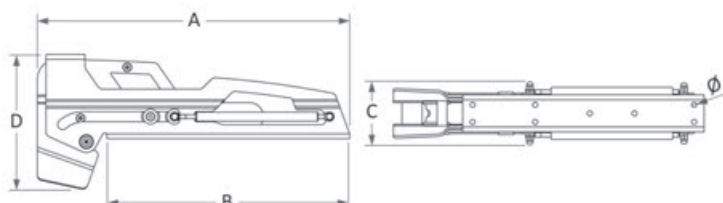

OSCULATI



Cruiser power plug and socket

16A IP67 IEC 60309-5

Marine plug and socket for 16A - 230V shore power cord. Made of PA6, fitted with high energy efficiency contacts and IP67 cover. The plug has an ergonomic grip design and the rotating ring fastens it tightly to the onboard socket with a watertight closure while the rubber cover ensures an IP44 rating protection when not connected. Simple and compact design for easy installation in any corner of the cockpit. In compliance with the IEC 60309-5 European safety standards.

Code	Model	Material	A	V
14.416.01	3P socket	Pa6	16	230
14.416.02	3P plug	Pa6	16	230

Available from November 2023

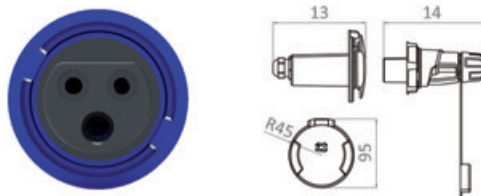

OSCULATI

Saturn cold-water shower

REGISTERED DESIGN / DISEGNO DEPOSITATO ONLY COLD

Flat hidden design. Horizontal or vertical mounting. Shower housing fitted with anti-vibration washer. The flow is adjusted by touching a push lock button that blocks the water jet and prevents waste.



▲ 15.471.01

▲ 15.471.02



▲ 15.471.11

▲ 15.471.12

Code	Montage	Colour	Min. inner space mm	Flange Ø mm	hose m	Carbon shower rod OPTIONAL
15.471.01	Horizontal	Chromed grey + white base	230	84	4	15.480.29
15.471.02	Horizontal	Chromed grey + chromed base	230	84	4	15.480.29
15.471.11	Vertical	Chromed grey + white base	160	120	4	15.480.29
15.471.12	Vertical	Chromed grey + chromed base	160	120	4	15.480.29

Available from December 2023

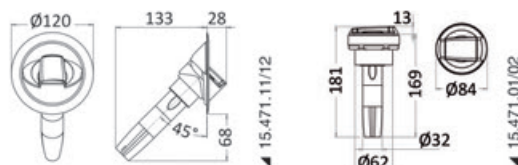

▲ 15.471.11/12

▲ 15.471.01/02



▲ video



▲ 15.471.01

▲ 15.471.12

▲ 15.480.29

Push lock button The button locks ON and the water jet keeps coming out



Oversize head and delicate water jet

Chromed brass body for strength and durability

Braided nylon hose for maximum flexibility

Mickey self-tensioning, modular and independent Bimini system



It can be used as sunshade or water protection and is UV-resistant. Simple to assemble, disassemble and store. It can be installed in many different ways. The 15°-inclination basis are small and can be easily in different places of the deck depending on the needs and provide a wider coverage than traditional systems.

Much more convenient than the standard systems available on the market (canopy not included).

Flexible pole for Mickey system

Fiberglass pole covered in carbon fibre with AISI316L stainless steel inserts.

Code	Ø mm	Overall height A cm	Distance gained with slope B cm	Net height from flush deck C cm	Recess D cm
46.826.14	16	137	34	129	8
46.826.15	16	153.5	38	145	8
46.826.17	16	170	43	160	8
46.826.18	16	185	47	175	8

Available from December 2023

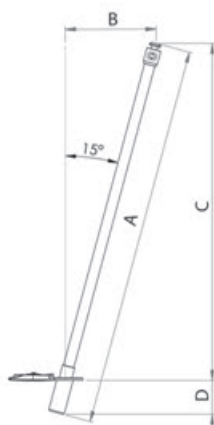

Stainless steel fastening bushing for Mickey system

Recess-fit AISI316 stainless steel bushing with fastening counter-ring. Available in 3 models.

Code	Description	For poles Ø mm	mm					min/max deck thickness F mm
			Ø A	B	Ø C	Ø D	E	
46.825.00	No lid	16	52	40	54	4	26	8/40
46.825.01	Rotary lid	16	58	58	54	5	26	2/50
46.825.02	Watertight lid	16	69	62	54	10	26	2/50

Available from December 2023



Fastening buckle for Mickey system

AISI316 stainless steel buckle for a simpler fastening of the Bimini top to the pole.

Code	mm		buckle slot mm	
	A	B	1	2
46.825.09	74	50	40x5	20x3

Available from December 2023





Easy under-platform ladder with handles

AISI316

AUTOMATIC HANDLES



Under-platform 4-step telescopic ladder made of AISI316 stainless steel. Fitted with overhanging rungs that make it easy to pull out the ladder and built-in climb-back handles that open and close automatically when pulling out or closing the ladder. 43-mm black plastic rungs for better comfort.

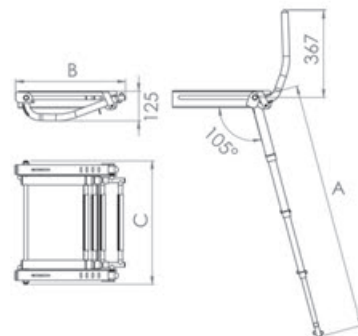

Code	Model	Steps		Length mm		Width C mm	Tube Ø mm
		No.	Colour	open A	folded B		
49.577.04	Normal	4	Black	1040	480	440	19/25/32/38
49.578.04	Big	4	Black	1040	480	520	19/25/32/38

Available from December 2023



Frigo° refrigerator

Compact and versatile refrigerators. Easy to install on any boat or vehicle. Convenient freezing compartment that can be pulled out if more refrigerating capacity is needed. Internal control panel to adjust the temperature.



Code	Volume l	V	←→ mm			kg	OPTIONAL frame
			width	depth	height		
50.960.00	50	12/24	380	490	530	17	50.960.30
50.960.02	85	12/24	475	545	630	21	50.960.32

Available from December 2023



Deluxe rubbing strake

AIS1316

SOLID S.S.

They protect against rubbing of the mooring lines. Made of thick mirror-polished AISI316 stainless steel. Available in two versions: with screws or studs.

Code	Length A mm	Width B mm	Mounting	Distance between holes mm
06.336.32	320	15	Screws	95
06.336.50	500	15	Screws	95
06.337.32	320	15	M5x40 studs	290
06.337.50	500	15	M5x40 studs	235

Available from November 2023



OSCOLATI

360° removable light with telescopic pole

EXTENSIBLE

COLREG72

USCG

Mooring light with stainless steel telescopic pole. Extensible from 70 to 120 cm, fitted with 360° white light (2 MN visibility). When not in use, the light can be stored in the peak since its size can be reduced and it can be mounted on a built-in base.

Code	Length cm	Light colour	V
11.039.90	70/120	Black	12

Available from January 2024



OSCOLATI



360° LED foldable pole, with adjustable slope

LED

For boats <20 m. Mirror-polished AISI316 stainless steel parts. IP65.

Code	Length	Light material	LED-bulb included
11.150.01	360	Black polycarbonate	12 V - 1.5 W

Available from December 2023

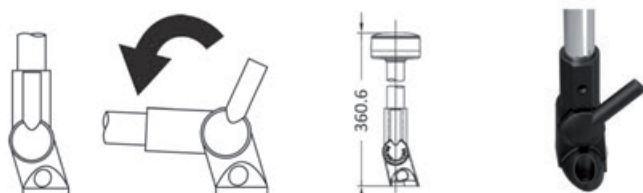

OSCULATI



Safe Energy Plus batteries

Fitted with double lid that prevents acid leaks from the accumulator in case of overturning.

- PbCa alloy expanded grid technology
- Oversized thickness plates
- Elevated starting capacity
- Hi-performance polyethylene bag separator
- +30% starting power
- 180° overturning without leaks
- DUPLEX watertight lid with centralized degassing
- Explosion-proof pad
- Extremely low self-discharge
- Vibration-resistant.

Code	Ah	Rush -18° C	V	Pole (+)	←→ mm			kg
					length	width	height	
12.480.02	65	640	12	RIGHT	242	175	190	15.6
12.480.03	80	730	12	RIGHT	278	175	190	17.4
12.480.05	95	850	12	RIGHT	310	175	190	20.5

LIONTRON®



Liontron lithium batteries

7 YEARS WARRANTY

INTEGRATED BMS

MADE IN GERMANY

Liontron lithium batteries totally replace an AGM or lead battery.

They are a lightweight solution still being a large power reserve and offering voltage stability even under very high load.

These batteries have been designed to fully meet the demanding requirements of a storage battery. Utmost safety and long duration are granted also by means of total discharge cycles thanks to the lithium most advanced technology.

Very long life cycle (**over 3000 cycles @ 90%**).

Possible parallel connection to increase capacity.

Fitted with BMS and built-in 4.0 Bluetooth for total control even on your smartphone at all times.

Code	V	Ah	Wh	Pole (+)	←→ mm			kg
					Width	Height	Depth	
12.460.01	12	55	704	LEFT	350	162	170	10.85
12.460.02	12	80	1024	LEFT	260	211	171	9.6
12.460.03	12	100	1280	LEFT	344	202	172	15.5
12.460.04	12	150	1920	LEFT	355	262	170	19.6
12.460.05	12	200	2560	LEFT	390	255	233	27.6

BCS

BALANCE OF STORAGE SYSTEMS



BOS LE300 lithium battery for AGM system extensions

MODULAR

PLUG & PLAY WITH CONVENTIONAL BATTERIES

MADE IN GERMANY

These lithium batteries are an extension for any 12 V lead-acid battery system, whether AGM or GEL. Their compact design and modularity allow to use these batteries for any application and capacity requirements.

Easy to install: connect the negative and positive poles to standard batteries to make immediate use of their auxiliary function.

Fitted with built-in BMS.

Code	Description	Ah total	V	←→ mm	kg
12.455.02	2 moduls x 25 Ah	50	12	175x229x134	6.8
12.455.04	4 moduls x 25 Ah	100	12	175x229x268	13.6

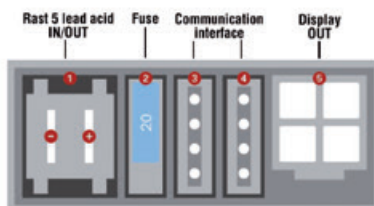
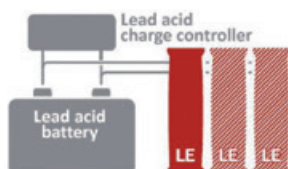

Heavy Duty fender

Made of high-quality soft PVC. **White** body and **blue** head. Fitted with inflation/deflation valve. Models OF4/OF6 can also be used as hull hauling rollers. 0.15bar max pressure.

Code	Model	∅		←→		PACKAGE
		cm	in	cm	in	
33.212.09	OF1	15	6	61	24	10
33.212.08 New	OF02	19	7.5	66	26	10
33.212.10	OF2	21	8	61	24	10
33.212.11	OF3	22	8.6	74.5	29	10
33.212.12	OF4	20.2	8	104	41	5
33.212.18	OF5	26.8	11.5	78	30.5	5
33.212.13	OF6	26.8	11.5	107	42.2	5
33.212.14 New	OF7	37	14.6	100	39.4	2
33.212.15 New	OF8	37	14.6	144	57	2

Available from December 2023

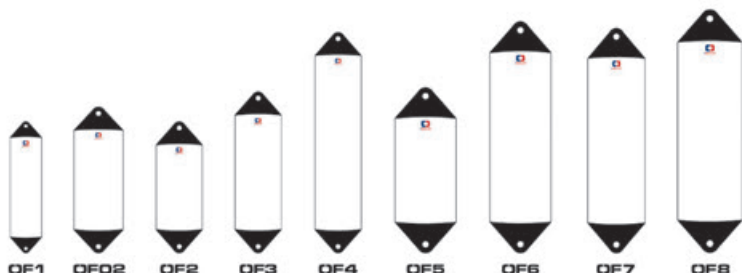

Heavy Duty fender and buoy

Made of high-quality soft PVC. **White** body and **blue** head. Fitted with inflation/deflation valve. 0.15bar max pressure.

Code	Model	∅		←→		PACKAGE
		cm	in	cm	in	
33.300.12	OA1	29	11.4	38	15	10
33.300.27	OA2	36	14.2	49	19.3	10
33.300.50	OA3	43	17	57	22.5	10
33.300.78 New	OA4	49	19.19	64	25.6	5



OSCULATI



G-fender Pack - set of fender profiles

The G-fender Pack comes in a carton display box inside which is a set including:

- 4 x deflated fenders
- 4 x 1.5-m long and 10-mm diameter lines
- 1 x inflating pump
- 4 needles for inflation
- 1 x bag with carton display.

The bag of the G-fender Pack can be used as a display box for self selling or as storage bag on the boat.

Code	Model	INCLUDED fender	←→ rope		←→ retail packaging cm
			∅ mm	length m	
33.540.03	OG3	33.539.03 4 pcs	10	1.5	49x21x23
33.540.04	OG4	33.539.04 4 pcs	10	1.5	57x25x25

Available from December 2023

OSCULATI



OSCULATI



Delux pull handle

FLUSH **ERGONOMIC**

38.511.00 Small stainless steel handle. The rotary opening system provides a **large and ergonomic grip** in a reduced space. For recess-fit mounting. Fitted with anti-vibration closing system.

Available from December 2023

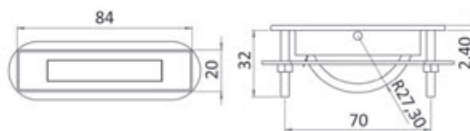

OSCULATI



Dome hidden mini cleat

AISI316

Ideal for fender profiles, dinghies and little boats. Made of mirror-polished AISI316 stainless steel.

Code	Base mm	Bore mm	Fastening	Breaking load kg
40.135.60	52x46	19	screws	2400

Available from November 2023

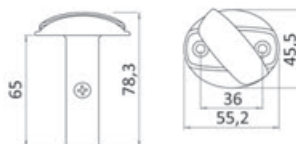

Gas hob with glass top

GAS **NON ELECTRIC**

Innovative hob for boats: safe, easy to use, ecologic and stylish. The burners are placed under the glass top and heat the surface so that the flame burns safely even in outdoor and windy places. Designed to be installed even on boats without a generator.

Code	No of burners	mm	V	Power kW	Current draw W	kg
50.601.02	2	460x280x70	12	2.4/2.8	15	4.8
50.601.12	2	545x450x70	12	3.8/4.4	17	10.2

OSCULATI

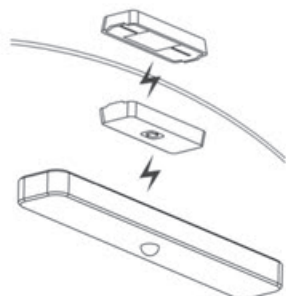

Battery-powered Bimini top light

MAGNETIC **WITH BATTERY**

LED strip light with magnetic clip. With the new magnetic fastening system, the strip light can be mounted in any position of the Bimini top. The clip is small and can be left on the Bimini top even when it's folded. The LED light is fitted with a long-duration battery, a light intensity control, a battery level indicator and a motion sensor for temporary switching on. Rechargeable via USB cable.

Code	V	W	No of LEDs	Battery
13.195.12	5	2	60	1300 mAh

Available from November 2023

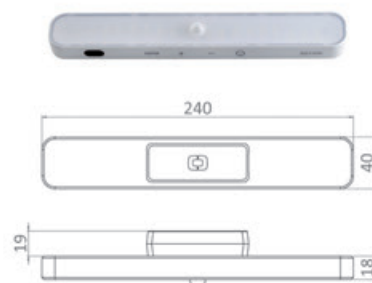

AUTOTERM diesel-powered air heater

AUTOTERM air heaters are independent, diesel-powered heating systems that can be easily installed on your boat or vehicle.

They are excellent products for spaces which need to be heated or dehumidified quickly. Equipped with built-in fail-safe systems and sensors that will automatically shut down the heater if any errors occur.

Accessories included:

- Petrol pump cable with connector. - Power cable. - Intake hose with silencer.
- Clamp for petrol pump. - Fuel dosing pump. - Control panel cable. - Fastening hose for fuel.
- 24-mm Ø thermal isolation. - Silencer with mounting kit. - 1-m exhaust pipe.
- 1.5-m nylon hose for fuel. - Mounting bracket. - Exhaust adapter.



Code	Model	Recommended for boats m		V	Power kW	Heating capacity 33/h	←→ mm	kg
		Mediterranean climate	Northern climate					
50.252.12	AIR 2D	8-10	7-9	2	2	86	310x119x145	2.9
50.254.12	AIR 4D	10-12	8-10	12	4	168	402x157x188	5.5
50.254.24	AIR 4D	10-12	8-10	24	4	168	402x157x188	5.5

**AUTOTERM control panel for air heaters**

Digital or analogic control panels are available depending on the requirements. The extension cord is compatible with both versions.

Code	Control panel	Language	OPTIONAL 5m-extension cable
50.251.11	Analogic	ALL	50.251.12
50.251.01	Digital	EN-DE-PL	50.251.12
50.251.02	Digital	EN-ES-IT	50.251.12
50.251.03	Digital	EN-FR-NL	50.251.12



▲ 50.251.11



▲ 50.251.01/02/03



▲ 50.251.12

AUTOTERM installation and air distribution kit for air heaters

Heaters can be customized depending on your the boat size and other needs by means of an installation kit with double, triple or quadruple air outlet.

The kits include all the accessories needed for a turnkey installation.



Code	Heater	Outlets	Open outlets	Adjustable and closable outlet	Connettors		←→ hose	
					Y-shaped	T-shaped	length m	Ø mm
50.252.62	AIR 2D	2	1	1	1	-	5	65
50.252.63	AIR 2D	3	1	2	1	-	8	65
50.254.63	AIR 4D	3	1	2	1	1	8	90
50.254.64	AIR 4D	4	1	3	2	1	10	90



Quick-coupling terminals for textile rig



Eye terminals for textile rig

ROPE LINE Made of polished AISI316 stainless steel.

Code	Ø-rope mm	←→ mm				Breaking load Kg
		A	D2	D3	L1	
05.220.04	4	5	8.5	8	45	1900
05.220.05	5	6	10.5	12	58.5	3200
05.220.06	6	9	13	14	71	5500

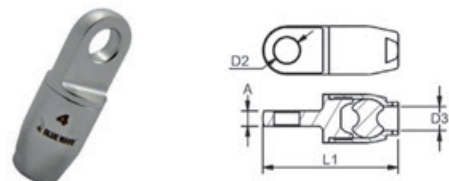

Fork terminals

ROPE LINE Made of polished AISI316 stainless steel.

Code	Ø-rope mm	←→ mm				Breaking load Kg
		A	B	C	L1	
05.221.04	4	6.5	16	9	53	1900
05.221.05	5	9	21	11	67	3200
05.221.06	6	11	26	13.5	83	5500

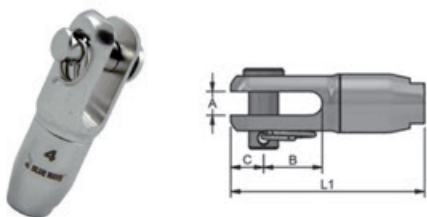

Threaded terminals

ROPE LINE Made of polished AISI316 stainless steel.

Code	Ø-rope mm	←→ mm			Breaking load Kg
		G	L1	L2	
05.222.04	4	5/16"	95	57	1900
05.222.05	5	3/8"	111	63	3200
05.222.06	6	7/16"	126	68	4600

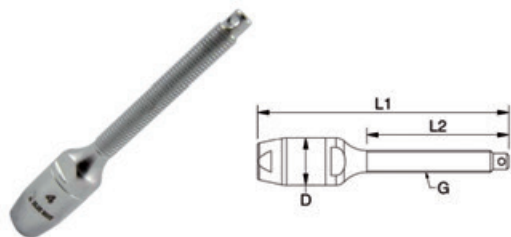

Lifeline textile system

ROPE LINE Made of polished AISI316 stainless steel.

Code	Description	Rope Ø mm	Thread	Pin Ø mm	Breaking load kg
05.230.01	Tumbuckle with chromed open cage	4	5/16"	8	1700
05.230.02	Single-snap shackle	-	M6	-	500
05.230.03	Threaded terminal for textile halyards to pair with shackle 05.230.02 and/or turnbuckle 05.230.01	4	M6	-	1100
05.221.04	Fork terminal	4	-	8	1900
05.231.00	Nylon sleeve for 10-mm bores	-	-	-	-

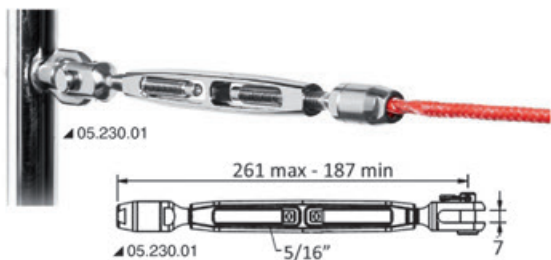

DOUGLAS MARINE AISI316 stainless steel bow shield

Mirror-polished AISI316 stainless steel bow shield, bored and countersunk. Supplied already bent, it adapts to the different bow shapes when installed. With oversized thickness, it resists even the most violent impacts.

U Douglas Marine

Code	Thickness	←→ mm	kg
01.290.01	2	340x520	1.78
01.290.03	2	680x450	3

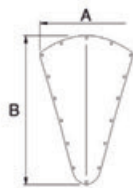

3-strand polypropylene line

POLYPROPYLENE **FLOATING**

Colour.		Ø mm	m
White	Black		
06.485.08	06.486.08	8	200
06.485.10	06.486.10	10	200
06.485.12	06.486.12	12	200
06.485.14	06.486.14	14	100
06.485.16	06.486.16	16	100



Available from January 2024

Smart Pins tightening system for turnbuckles

Fast and innovative system, an option to the traditional split pins. Made up of an AISI316 stainless steel pin and a Velcro strap for a safe use of the rigging terminals. Slip the pin into the terminal hole and tighten the Velcro strap around the bottle screw. **4-pc package.**

BLUE WAVE

Code	Thread size		D mm	H mm	B mm	L mm
	mm	G				
07.597.00	M6	1/4"	2	8	16	100
07.597.01	M8 - M10	5/16" - 3/8"	2.5	10	16	130
07.597.02	M12	7/16" - 1/2"	3.2	13	20	180
07.597.03	M16 - M20	5/8" - 3/4"	4	20	20	220

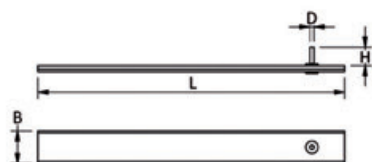

Extreme plus watertight LED torch

Fit with Cree XRE high-efficiency LEDs, watertight up to 1 m. Four operating modes: **full light, medium light, low light, flash.**



Code	Version	Watertight up to	Lumen/Candles		Range m		Duration h	Body color	←→	Battery	kg
			Full light	Half light	Full light	Half light					
12.170.12	Extreme Plus	1	750	325	70	2 Hz	9.5/24.5/137	Fluo yellow	146x160x Ø75 mm	3 C (not included)	515

Multipurpose independent LED navigation lights

LED

Internally powered by 3 x AA batteries, duration up to 24 hours. Floating and extractable by snap-fit. Floating and IP67 watertight. CE certified.

Code	Type	Functions	Accessories included	Fixing
11.090.11	360° white	Continuous light + Flash light	wivel joint for light alignment; adhesive base for rubber dinghies; round base for flat mounting	Click/Clac fork fixing of the light on the base
11.090.12	Bicolour red/green	Green light 112.5° Red light 112.5° Red+green combined light	wivel joint for light alignment; adhesive base for rubber dinghies; round base for flat mounting	Click/Clac fork fixing of the light on the base

Available from December 2023



Multipurpose independent LED navigation lights on telescopic pole

LED

Mounted on a 790/1358-mm telescopic pole. Internally powered by 3 x AA batteries, duration up to 24 hours. IP67 watertight. CE certified.

Code	Type	Functions	Accessories included	Fixing
11.090.13	White 360° + Bicolour red/green	White continuous light + Flash light Red light 112.5° Green light 112.5° Red + green combined light	Adhesive base for inflatable boats; round base fixing on top; wall base	Click/Clac fork fixing on the base

Available from December 2023



SUNPOWER™

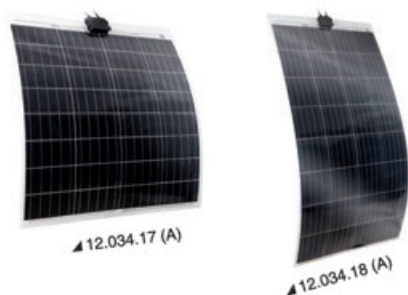

ENECOM flexible solar panels

MADE IN ITALY

Built with high-performance aerospace solar cells. Latest generation ultrathin and ultraflexible panels (1.7 mm). 17.25% mono-crystalline cell efficiency. The panel is a sandwich construction made up of a plastic support + solar cell + UV-resistant epoxy resin surface coating. Installation by means of double-sided tape. Connection cable with plug, included. **Version A:** mono-crystalline panels.

Code	Max power (Wp)	Thickness mm	V	Cable cm	mm	kg	Version
12.034.17	75	1.7	12	100	739x731	1.2	A
12.034.18*	180	1.7	12	100	1535x671	2.6	A

To be completed with voltage regulator and MC4 connectors if needed depending on the system requirements.

* Provided with fastening eyelets.

VICTRON AGM Deep Cycle batteries

SERVICES / SERVIZI

STARTING / AVVIAMENTO

Fitted with VRLA (Valve Regulated Lead Acid) technology, which means that the batteries are sealed. Gas will escape through the safety valves only in case of overcharging or cell failure. Excellent high current performance.

Low self-discharge that enables these batteries to be stored for up to a year without recharging. Very fast charging time, irrespective of how deep and for how long the battery has been discharged previously.



Code	A-h	Rush A/18° EN	W-h	V	Pole (+)	mm			kg
						length	width	height	
12.416.00 New	90	400	756	12	LEFT	350	167	183	27
12.416.01	110	500	924	12	LEFT	350	171	220	32
12.416.02	130	550	1092	12	LEFT	410	176	227	38
12.416.04 New	165	600	1386	12	LEFT	485	172	240	47
12.416.05 New	220	650	1848	12	LEFT	522	238	240	65
12.416.03	240	650	2016	12	LEFT	522	240	224	67

Atria II LED ceiling light for recess mounting

Stainless steel body. Satin-finish glass diffuser. Dual fixing system: with hidden screws or with internal stainless steel springs.

Code	Finish	V	W	Switch	IP rating	Lumen	K	LED beam	No. of LEDs	Light colour
13.447.22	Mirror-polished	12/24	8	No	IP65	560	3000	80°	1	<input type="checkbox"/> White
13.447.23	Mirror-polished	12/24	8	Yes	IP40	560	3000	80°	1	<input type="checkbox"/> White

Dimmerable with 14.482.00

Available from December 2023

**Montserrat II LED ceiling light for recess mounting**

White epoxy-powder coated aluminium body, stainless steel finish ring.

Code	Finish	V	W	Lumen	K	LED beam angle	No. of LEDs	Light colour
13.445.08	Mirror-polished	12/24	8	560	3000	80°	1 LED HD	<input type="checkbox"/> White

Available from December 2023

**Vega II LED ceiling light for recess mounting**

Aluminium body coated with white epoxy resin. Stainless steel ring. Satin-finish glass diffuser.

Code	Finish	V	W	lumen	K	LED beam angle	No of LEDs	Light colour
13.433.12	Mirror-polished	12/24	8	560	3000	80°	1	<input type="checkbox"/> White

Available from December 2023

**Capella II LED ceiling light for recess mounting**

Nylon/fiberglass body. Stainless steel ring. Satin-finish glass diffuser.

Code	Finish	V	W	lumen	K	LED beam angle	No. of LEDs	Light colour
13.433.33	Mirror-polished	12/24	3.5	240	3000	80°	1	<input type="checkbox"/> White
13.433.34*	Mirror-polished	12/24	3.5	240+40	3000	80°	1+1	<input checked="" type="checkbox"/> White

* With red night light

Available from December 2023

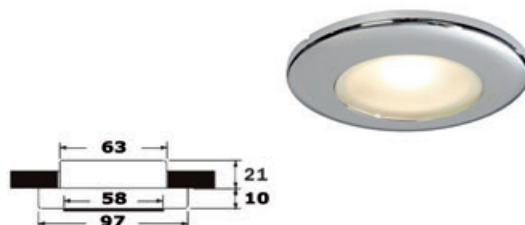
**Phad II LED ceiling light for recess mounting**

IP65 **AISI304**

Polycarbonate diffuser.

Code	Finish	V	W	Lumen	Light colour	K	Angle of radiation
13.430.11	Mirror polished	12/24	6	286	<input type="checkbox"/> White	3000	110°

Available from December 2023

**Laguna LED spotlight**

Turned brass body, satin-finish glass diffuser.

Code	Finish	V	W	Switch	Lumen	K	LED beam angle	No of LEDs	Light colour
13.439.15	Chromed brass	12/24	3	Yes	88	3000	60°	1 x HD LED	<input type="checkbox"/> White
13.439.03 New	Chromed brass, satin finish	12/24	2	Yes	200	2700	60°	12	<input type="checkbox"/> White
13.439.21*	Chromed brass	12/24	3	Yes	88	3000	60°	1 x HD LED	<input type="checkbox"/> White

* Lightweight version with round base plate.

Available from December 2023



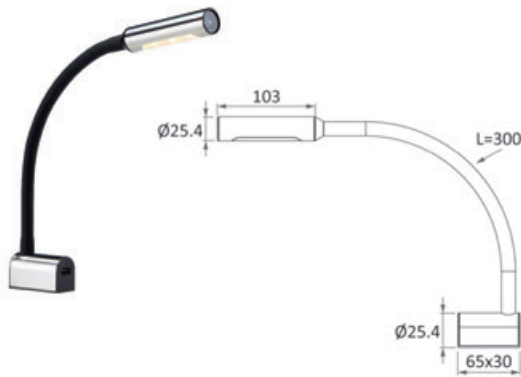

Articulated reading LED spotlight

Polished stainless steel spotlight and baseplate. Articulated arm coated in black silicone. Fitted with 2.1A USB socket on the base. Touch switch on the head. Powerful light beam with 3 x white LEDs + 2 x red LED for night light.

Code	Finish	V	W	Switch	Lumen	K	LED beam	No of LEDs	Light colour	mm	
										base	arm
13.237.08	SS + black silicone	12/24	4,5+1,0	Touch	430	3000	50°	3+2	White + Red	65x37	300

Available from December 2023



LED light strip

IP66 **LED**

Light strip made of clear thermoplastic with 2835 LEDs. 4-screw mounting or with double-sided tape. 100% watertight. LEDs are embedded in the front resin element. ideal for indirect lighting in dinettes and cabins.

Code	V	W	Lumen	K	LED beam	No of LEDs	LED colour	Length mm	Section mm
13.844.01	12	3	265	5800	120°	17	White	229	22x11
13.844.06	12	6	529	5800	120°	45	White	508	22x11
13.844.02	New	12	3	54	-	17	Blue	229	22x11
13.844.07	New	12	6	153	-	45	Blue	506	22x11
13.844.04	New	12/24	1.2	15/61/18/94	-	15	RGBW*	225	22x11
13.844.05	New	12/24	2.4	42/169/46/234	-	39	RGBW*	508	22x11

* Selectable colors



Underwater LED light for gangplanks, transoms and hulls

Black anodized light alloy body. 12/24V power. Version A: cylindrical, 32-mm Ø, 1/2" NPT rear thread. To be paired with stainless steel drain plug 18.542.00 where the light has to be screwed. Version B: to be screwed. Fitted with remote control (included) up to 15 metres. 3 modules to set colours, sequence, strobo mode, flash, etc.

Code	V	Lumen	W	LED colour	Version
13.639.01	12/24	1000	10	White	A
13.639.02	12/24	220	10	Blue	B
13.639.05	12/24	300+420+135	12+12+13	RGBW*	B

* Switch Red+Green+Blue lights on at the same time to get white light

Available from November 2023

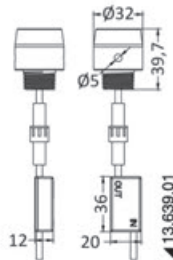

MARINCO cable with plugs

Special cable "Sea Water Resistant", preassembled with Marincos plugs.



Code	Length m	A	Cable colour	Assembled with			Cable section mm
				cable	Marincos plug	cover	
14.211.51	15	32A 230V	Yellow	14.593.00	14.587.03	14.587.04	3x6

* Quadrupole cable: 3 poles, 4 wires.

Dual USB port current plug

It matches any CARLINGSWITCH, Marina R and Marina TOP switch. It fits all types of frame 14.197.xx.

Code	Description	V	A	mm
14.195.63	Dual USB-A+C plug + 12/24 V voltmeter	12/24	3 + 3	49x25x51

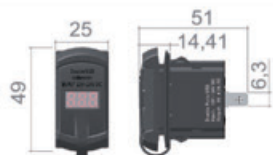

Preassembled wiring kit for FLAT switches

14.215.20 Ideal for fast installation and repairs of 20A switches. Jumper cable for PUSH ON or ALWAYS ON configuration of the LED. It makes 12V switches compatible with 24V voltage. The kit comes with 15-cm long cables.



Available from November 2023

Circuit breaker

Easy-to-install safety magnetic circuit breaker. It stops the current flow when the two parts come into contact. It opens the circuit at a 15-mm distance. Ideal for wet bars with electric cooking ranges, hydraulic/electric gangplanks, end-of-stroke devices for electric tables.

Code	Mounting	Fastening	Version	Material	mm	A
14.390.01	Recess	Adhesive	Round	ABS	Ø19 x 23	0.5
14.390.02	External	Screws	Rectangular	Zinc alloy	31x14x7.5	0.5

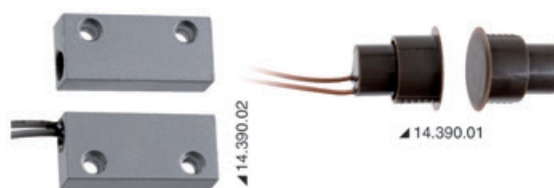

Available from December 2023

PCP Compact electrical panel with circuit breaker and LED

IP66 Black polycarbonate cabinet. Toggle switches with built-in enabling LED. Equipped with resettable automatic circuit breakers. Utilities with RED LED backlight writings when out of service and GREEN LED when activated.

Code	No of switches	Switch type	Circuit breaker power	mm
14.860.08	8	1°/2°/3°/4°/5°/6°/7° = ON-OFF; 8° = (ON) - OFF	2x5A; 4x10A; 2x15A	235x100



Dual USB port current plug

It matches any CARLINGSWITCH, MARINAR and Marine TOP switch. It fits all types of frame 14.197.xx.

Code	Description	V	mm	A
14.195.63	Double USB-A port + 12/24 V voltmeter	12/24	49x25x51	3 + 3



Lighter and/or USB socket

Made of nylon and fit with protection cap to make them waterproof. 12/24V input, 5V USB output.

Black	White	Description	A
14.516.05	14.516.15	A-type USB plug + C-type	4.8*
14.516.06	14.516.16	Plug/lighter plug + double USB-A + USB-C with panel	4.8*

* 3 + 3 if used one at a time

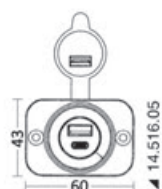



12/24V USB plugs

USB connection to plug into standard current/lighter sockets.

Code	Description	V	A	Fuse + LED activation
14.517.19	Double USB type A+C	12/24	2.4	Yes

Digital voltmeter/ampere meter and sockets for recess mounting

With or without front panel.

Code	8/32V digital voltmeter	0/10A digital ammeter	Power outlet	Dual USB plug Type A+C	A	Version
14.516.30	x			x	3+3	For recess fit
14.517.52	x			x	3+3	For recess fit
14.517.53	x		x	x	3+3	For recess fit
14.517.29	x	x	x	x	2,4+2,4	For recess fit



Europump Smart 5-diaphragm fresh water pump

VARIABLE SPEED

Fresh water pump fitted with an electronic system that adjusts the motor speed to the water flow demand without generating any pulsations. Very silent yet having an elevated suction capacity. It can run dry for maximum reliability. Fitted with 3/4" straight hose connector, 3/4" 90° elbow hose connector, 1/2" thread fitting and 3/4" quick coupling filter.

Code	V	Flow l/min	Current draw A	Max pressure PSI/bar
16.515.12	12	18.9	10	70/4.8
16.515.24	24	18.9	5.5	70/4.8

Available from December 2023



Universal panel switch for bilge pumps

Universal for all bilge pumps with floating or electronic device. Fitted with: Marina **double-LED** toggle switch. 3 functions: automatic, off, manual with spring return to OFF position to prevent leaving the pump turned on. Safety fuse.

Code	For pumps	Current draw A	mm
16.606.30	12/24 V	25	75x60

Available from December 2023



OSCULATI

Hyperflow axial electric blower



Water resistant product compliant with ISO 8846 and CE - RoHs Suitable for effectively ventilating and cooling both cabins and engine compartments. It is characterized by a high air volume with a low current absorption Both vertical and horizontal installation.

Code	V	Inlet/outlet m ³ /min	F _{low} m ³ /min	Current draw A	Outlet Ø mm	mm	OPTIONAL hose
16.175.01	12	7.6	5	6	102	204x152x135	16.104.36
16.175.02	24	7.6	5	3	102	204x152x135	16.104.36

Available from November 2023

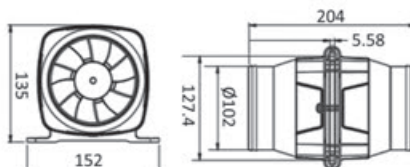

Shower series

Ideal for indoor/outdoor showers, fitted with 3 x lower connection hoses made of stainless steel sheath.

Code	Function	Handle	Base Ø mm	Overhang mm	Mounting neck
17.048.00	Hot/cold water mixer	Round	42	45	32-mm Ø + 37-mm long



Smart control panel for windshield wipers - universal

Control system including a control panel + relay box connected via a CAN BUS cable with 2 plugs. The 2-wiper unit has 1 input while the 3-wiper unit has 2 inputs and 8 poles (in parallel) that can be used together or alone.

Functions:
 The windshield wipers can be activated singularly or all together.
 3 intermittent levels (4 with a one-speed motor).
 1 or 2 continuous speed levels.
 Parking cycle.
 Synchro wipers for all speed levels.
 Automatic washing cycle.
 A second panel can be added for a second station.
 Internal fuse with auto reset for each motor.
 Reverse pole protection.

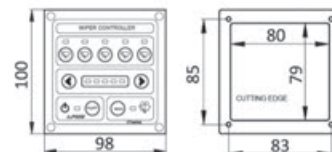

Code	mm	Version for	V
19.756.02	100x98	2 windshield wipers	12/24
19.756.03	100x98	3 windshield wipers	12/24

MARCO brass horn with compressor

Type approved RINA, suitable for pleasure boats over 12 metres and for commercial boats (fishing or similar) from 12 to 20 metres; white lacquered brass horn.; includes compressor and mounting accessories.



Code	Initials	Finishing	V	Type	Length mm	Ø mouth mm
21.440.12	PW2	<input type="checkbox"/> White paint	12	Classic	460	200
21.440.13	New PW2-BB	<input checked="" type="checkbox"/> Black paint	12	Classic	460	200
21.440.24	PW2	<input type="checkbox"/> White paint	24	Classic	460	200
21.440.25	New PW2-BB	<input checked="" type="checkbox"/> Black paint	24	Classic	460	200



SCOUT removable ultra-compact VHF antenna

FOAM INJECTED

100% waterproof fiberglass VHF antenna. IP69 rating. It can be easily screwed off its support. UV-resistant coating and watertight internal gasket that prevents water ingress. It comes with its support and mounting kit.



Code	Length mm	kg	Max applicable power W	Gain dB	Coaxial cable m	Ø Base mm
29.993.01	220	0.11	50	1	5	55



GARMIN UHD2 echoMAP™ chartplotter



Available in a 5-inch or 7-inch bright colour display, they're offered in a new graphic interface with a modern homepage and several innovative functions. The built-in Wi-Fi® enables seamless sharing of sonar - CHIRP traditional and ClearVü - and user data (waypoints and routes) between two Garmin compatible units to target and identify a wider array of images and a crisp view of structures in vivid color schemes. The EchoMAP™ UHD2 chartplotters support the Garmin Navionics+™ and Garmin NavionicsVision+™ charts. Upgrade your charts through the ActiveCaptain App in a simple and fast way.

Code	Garmin code	Model	Colour display	Sonar power W	CHIRP		Panoptix™ compatibility	Stern transducer included	←→ cm
					ClearVü	SideVü			
29.063.06	010-02679-00	EchoMap UHD2 62SV	6"	500	Yes	Yes	Yes	-	20.6x13.1 x6.7
29.063.07	010-02679-01	EchoMap UHD2 62SV	6"	500	Yes	Yes	Yes	GT54UHD-TM	20.6x13.1 x6.7
29.063.08	010-02683-00	EchoMap UHD2 72sv	7"	500	Yes	Yes	Yes	-	21.8x14.2 x8.1
29.063.09	010-02683-01	EchoMap UHD2 72sv	7"	500	Yes	Yes	Yes	GT54UHD-TM	21.8x14.2 x8.1
29.063.10	010-02678-00	EchoMap UHD2 92sv	9"	500	Yes	Yes	Yes	-	26.4x16.6x8
29.063.11	010-02678-01	EchoMap UHD2 92sv	9"	500	Yes	Yes	Yes	GT56UHD-TM	26.4x16.6x8



▲ 29.063.06/07



▲ 29.063.06/07



▲ 29.063.08/09/10/11



▲ 29.063.08/09/10/11

Raymarine



RAYMARINE Lighthouse Chart

29.070.03 The new Raymarine LightHouse Charts brings a new level of clarity to marine GPS navigation. These flexible marine charts can be downloaded for Axiom and Element display via the RayConnect dedicated app. When you buy the charts, you can download two regions. The Premium version offers satellite images and points of interest such as service centres, dealers, workshops, services, main roads and restaurants. The LightHouse Charts are also available with global coverage areas. See more on www.raymarine.it



Epirb1 OCEAN SIGNAL with manual GPS CAT2

MED type-tested. Manual-release Float-Free with 66-channel built-in GPS. Very bright LEDs. In compliance with Class 2 = -20°C +55°C. Slip-in antenna and quick coupling bracket. Safety strap. 48h operating time. 5-year warranty. 10-year battery duration.

Code	Model	←→ mm	📏
29.646.02	EPIRB1	178x89	422



Pro OCEAN SIGNAL Epirb with CAT1 automatic GPS

MED type-tested. **Automatic-release** Float-Free with 66-channel built-in GPS. Very bright LEDs. IMO & GMDSS. In compliance with Class 2 = -20°C +55°C. It meets all the international standards, IMO and GMDSS included. Slip-in antenna. 48h operating time. 5-year warranty. 10-year battery duration.

Code	Model	←→ mm	📏
29.647.02	EPIRB1 Pro	237x191x121	1250

GLOMEX weBBoat® Link PRO 5G

5G/4G/WI-FI COSTAL INTERNET

DUAL MICRO SIM

weBBoat® Link PRO 5G is the new WORLDWIDE Dual SIM 5G/4G/Wi-Fi Coastal Internet system to get the internet on board and a secure Wi-Fi hotspot inside and outside the boat available to be used on 32 devices at the same time.

weBBoat® Link PRO 5G is fitted with 4 x 5G and 2 x 2.4/5GHz MIMO Wi-Fi antennas for optimizing the speed of data transfers up to 15 miles off the coast.

weBBoat® Link PRO 5G allows you to use different types of Internet connection, even combining Internet via a 5G/4G mobile network, Wi-Fi and satellite connection (if any). The performance will be at the same level of a fiber network but totally wireless and therefore ideal to be used on board.

Among the main weBBoat® Link PRO 5G features are:

- Brand new Firmware and user interface with new functions.
- Carrier aggregation: flexible bandwidth option in LTE that allows to combine multiple bands of the carrier into one big channel and therefore significantly improve the achievable data rates and speed.
- Automatic APN: easier and faster configuration with the automatic selection of your SIM card carrier APN.
- Easy configuration and management with weBBoat® App.
- Priority function: possibility to choose which type of Internet connection is used and in which assigned priority order between Wi-Fi of marina/internet data via SIM cards installed inside the unit/SAT - satellite internet.
- Encrypted real-time peer-to-peer connection for remote set-up & service.
- Built-in speed-test feature.

weBBoat® Link PRO 5G



Code	Version	V	Range	5G download speed	4G download speed (LTE) CAT16	Internet antennas
29.921.11	weBBoat Link PRO	10/30 Vdc	15 miles	up to 2.5 Gbps	up to 1 Gbps	4 x 5G + 2 x 2.4/5GHz MIMO Wi-Fi antenna

GLOMEX weBBoat® Link PRO 5G EXT

5G/4G/WI-FI COSTAL INTERNET

DUAL MICRO SIM

weBBoat® Link PRO 5G EXT is the new Dual SIM 5G/4G/Wi-Fi Coastal Internet system working worldwide. It consists of a unit to be placed inside the boat + 4 x 5G high-gain antennas to be placed outside and 4 x LMR200 7-m coaxial cables to surf the Internet and to have a safe Wi-Fi hotspot both inside and outside the boat up to 20 miles from the coast.

Up to 32 devices can be used at the same time with no signal or performance degradation.

weBBoat® Link PRO 5G EXT allows you to use different types of Internet connection, even combining Internet via a 5G/4G mobile network, Wi-Fi and satellite connection (if any). The performance will be at the same level of a fiber network but totally wireless and therefore ideal to be used on board

Among the main weBBoat® Link PRO 5G are:

- Brand new Firmware and user interface with new functions.
- Carrier aggregation: flexible bandwidth option in LTE that allows to combine multiple bands of the carrier into one big channel and therefore significantly improve the achievable data rates and speed.
- Automatic APN: easier and faster configuration with the automatic selection of your SIM card carrier APN.
- Easy configuration and management with weBBoat® App.
- Priority function: possibility to choose which type of Internet connection is used and in which assigned priority order between Wi-Fi of marina/internet data via SIM cards installed inside the unit/SAT - satellite internet.
- Encrypted real-time peer-to-peer connection for remote set-up & service.
- Built-in speed-test feature.

Available on request with 10- or 20-m cable.

weBBoat® Link PRO 5G EXT



Code	Version	V	Range	5G download speed	4G download speed (LTE) CAT16	Internet antennas
29.921.12	weBBoat Link PRO EXT	10/30 Vdc	20 miles	up to 2.5 Gbps	up to 1 Gbps	4 x 5G outdoor antennas + 2 x 2.4/5GHz MIMO Wi-Fi antenna

Extra soft fender cover

OSCOLATI

Cut-to-size head and bottom adjustable by means of strap and cam cleat. Made of soft texturized and elastic polyester fibre with anti-abrasion weaving. They cover the fenders perfectly, are UV-resistant and washable.

For Polyform model	Navy blue	Black	Light grey RAL7042	Dark grey RAL7043	Beige	Claret	for fender ±10% mm	
							⌀	KL
F4	33.480.04	33.481.04	33.482.04	33.483.04 New	33.484.04 New	33.485.04 New	220	1040
A4	33.480.18	33.481.18	33.482.18	33.483.18 New	33.484.18 New	33.485.18 New	550	710



▲ 33.483.xx



▲ 33.484.xx



▲ 33.485.xx



▲ 33.480.0x; 33.481.0x; 33.482.0x

▲ 33.480.xx; 33.481.xx; 33.482.xx

Eclipse flush latch

38.161.6x/7x - Efficient flush latch with flush design
even more elegant in Black Line version



Eclipse LIFT & TURN flush latch (with compression closure) - SMALL

COMPRESSION SYSTEM

EXTRA LARGE HANDLE

Featuring a very comfortable grip, it offers all the best characteristics in a single flush deck design model.

- Flush design.
- Large ergonomic handle.
- 360° rotation.
- Handle can be lowered every 90°.
- Open/close indicator.
- Ergonomic nut for easy calibration and emergency exit.
- Straight cam suitable for sliding doors.
- Two-position cam.
- Plastic spacer with marks for customized cut.

Polished SS version	Black SS version	Lock	Outer Ø mm	Bore Ø mm	Bulkhead thickness mm	Stop stroke mm
38.161.01	38.161.61 New	No	60	50	3-26	22-94
38.161.02	38.161.62 New	Yes	60	50	3-26	22-94

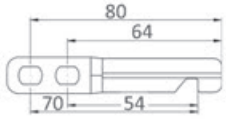

▲ Universal straight cam included



▲ Angled cam included



▲ Spacer included



▲ Key for 38.161.02

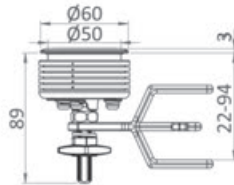

OSCOLATI



▲ 38.161.01

▲ 38.161.02



▲ 38.161.62

▲ 38.161.61

Eclipse LIFT & TURN flush latch (with compression closure) - MEDIUM

COMPRESSION SYSTEM

EXTRA LARGE HANDLE

Featuring a very comfortable grip, it offers all the best characteristics in a single flush deck design model.

- Flush design.
- Large ergonomic handle.
- 360° rotation.
- Handle can be lowered every 90°.
- Open/close indicator.
- Ergonomic nut for easy calibration.
- Ergonomic nut for emergency exit.
- Straight cam suitable for sliding doors and having two different positions.
- Two-position cam.
- Plastic spacer with marks for customized cut.

Polished SS version	Black SS version	Lock	Outer Ø mm	Bore Ø mm	Bulkhead thickness mm	Stop stroke mm	Kit	No. of latches per kit (same key)
38.161.31	38.161.71 New	No	75	60	5-36	30-101	No	-
38.161.32	38.161.72 New	Yes	75	60	5-36	30-101	No	-
38.161.42	-	Yes	75	60	5-36	30-101	Yes	2
38.161.43	-	Yes	75	60	5-36	30-101	Yes	3
38.161.44	-	Yes	75	60	5-36	30-101	Yes	4
38.161.45	-	Yes	75	60	5-36	30-101	Yes	5

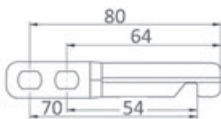

▲ Universal straight cam included



▲ Angled cam included

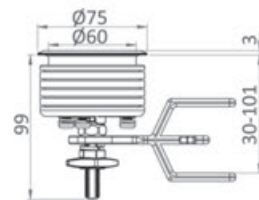

OSCOLATI



▲ 38.161.32

▲ 38.161.31

▲ 38.161.71/72



▲ Spacer included



▲ Key for 38.161.32; 38.161.4x

OSCULATI



Rapid Lock system for fenders and bimini tops

AISI 316 **FLUSH**

Quick coupling/release system for fast fastening of fenders, Bimini tops, etc. Made of AISI316 stainless steel. When not in use, the recess base is flush with the surface. Fitted with Dyneema ring for fastening to the fender/Bimini top.

Polished SS version	Black SS version	Description	mm
39.840.00	39.840.60 New	Base Rapid Lock	Ø 33 x 53 h
39.840.01	39.840.61 New	Removable part	Ø 39 x 30 h
39.840.10	39.840.10	Dyneema ring	Ø 7

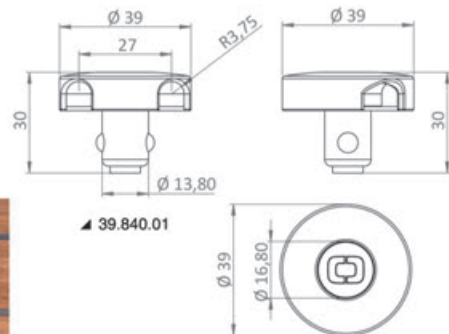

Nordik cleat - Black Line

AISI 316 Made of stainless steel with a surface coating that integrates a black layer in the steel cleat whose surface becomes extremely hard and corrosion-resistant.

Code	A mm	B mm	C mm	D mm	E mm	Stud Ø mm
40.137.51	150	45	90	47	30	8
40.137.52	205	55	120	69	35	10
40.137.53 New	265	70	150	83	40	12



OSCULATI

Ghost II hidden cleat

AISI 316 **PERFECT GRIP** **SMOOTH MOVEMENT**

Watertight cleat with mounting screws from above. Very smooth operation. Ergonomic lifting handle. Fluorinated rubber O-ring for smooth sliding. ENAVE approved in compliance with ISO 15084:2003.

Polished SS version	Black SS version	A mm	B mm	C mm	D mm	E mm	F mm	Ø G mm	Ø H mm	Breaking load kg	Mounting	OPTIONAL drain pipe
40.155.16	40.156.16 New	160	38	15	28	47	48	14	24	800	3 x M6 screws	40.155.72
40.155.24	40.156.24 New	240	52	20	44	70	72	18	32	2050	3 x M8 screws	40.155.74
40.155.31	40.156.31 New	310	68	25	56	85	93	22	41	5200	3 x M10 screws	-



Spider hinge

AISI316 HEAVY DUTY

38.527.01 Polished AISI316 stainless steel spider hinge. Ideal for high-load hatches and pantograph opening systems up to 180°. Its dynamic geometry keeps the hinge far from the seal of the door or hatch.

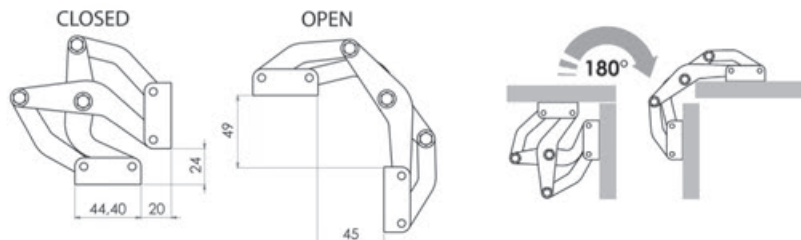

Tapered base for pulpits

AISI 316 Made of mirror-polished AISI316 stainless steel, 1 x 8-mm mounting stud.

Code	Slope	Base mm	Height mm	For pipe Ø mm	Optional studs and bolts	Studs mm
41.409.31*	45°	84x48	70	30	40.142.08	8

Aerodynamic version

OSCULATI



Polybridge II + EVA folding gangplank made of carbon

FPT (technical polyurethane) construction. Anodized aluminium hinges. Wheels with stainless steel case to lift the gangplank. Double pivoting lock. It can be mounted with a single pin to let the gangplank swing, or with two pins for mere tilting (both pins included).
]The walking surface can be fitted with a white anti-slip cover, or covered in brown or grey EVA.

Code	Length m	Width cm	Length when folded m	Thickness when folded cm	Safety capacity kg	Q kg	Version
42.663.00	2,2	34	1,1	14	140	8	nonslip
42.663.10 New	2,2	34	1,1	14	140	8	w/brown EVA
42.663.20 New	2,2	34	1,1	14	140	8	w/grey EVA
42.663.61 New	2,60	34	1,3	14	140	10	nonslip

42.659.10; 46.659.25; 42.660.25 *OPTIONAL fastening bushing*

Available from November 2023



42.663.00

42.663.00

42.663.00

42.663.00/61



Olive shape propeller shaft

Fitted with stainless steel pins and nuts.

Zinc	Aluminium	Hole		Zinc	Aluminium	Hole			
		mm	inches			mm	inches		
43.800.19	-	19	3/4"	43.800.45	43.802.45	New	45	-	
43.800.22	43.802.22	New	22	7/8"	43.800.50	43.802.50	New	50	-
43.800.25	43.802.25	New	25	-	43.800.51	43.802.51	New	51	2"
43.800.26	-	-	25.4	1"	43.800.55	-	-	55	-
43.800.28	-	-	28.6	1" 1/8	43.800.57	43.802.57	New	57.15	2" 1/4
43.800.30	43.802.30	New	30	1	43.800.60	43.802.60	New	60	-
43.800.32	43.802.32	New	31.8	1" 1/4	43.800.63	-	-	63	2" 1/2
43.800.35	43.802.35	New	35	1" 3/8	43.800.65	-	-	65	-
43.800.38	43.802.38	New	38	1" 1/2	43.800.70	43.802.70	New	70	-
43.800.40	43.802.40	New	40	-	43.800.75	-	-	75	-
43.800.44	43.802.44	New	44	1" 3/4	43.800.80	-	-	80	-

OSCULATI

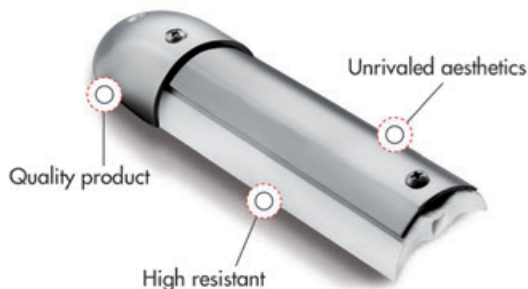

Fender profiles

AISI316

Made-in-Italy AISI316 stainless steel C-shaped fender profiles. 3-m standard length, tapered and mirror-polished. Each bar is pickled and passivated for optimum resistance in salty environment. They can be used with dedicated UV-resistant PVC base plates available in white, black and grey, and with dedicated mirror-polished AISI316 stainless steel terminals.

Code	Description	Bore type	mm			Rods m	Bore centre distance	White PVC	Grey PVC	Black PVC	SS terminal
			A	B	H			base	base	base	
44.480.20	Profilo 20	flared	19	1.5	4.6	3	198	44.481.33	44.481.43	44.481.53	44.484.33
44.477.20	Profilo 20	deep-drawn	19	1.5	4.6	3	186	44.481.35	44.481.45	44.481.55	44.484.35
44.480.30	Profilo 28	flared	28	1.5	7	3	198	44.481.36	44.481.46	44.481.56	44.484.36
44.480.38	Profilo 35	flared	35	1.5	9	3	198	44.481.37	44.481.47	44.481.57	44.484.37

Base in 24-m-roll

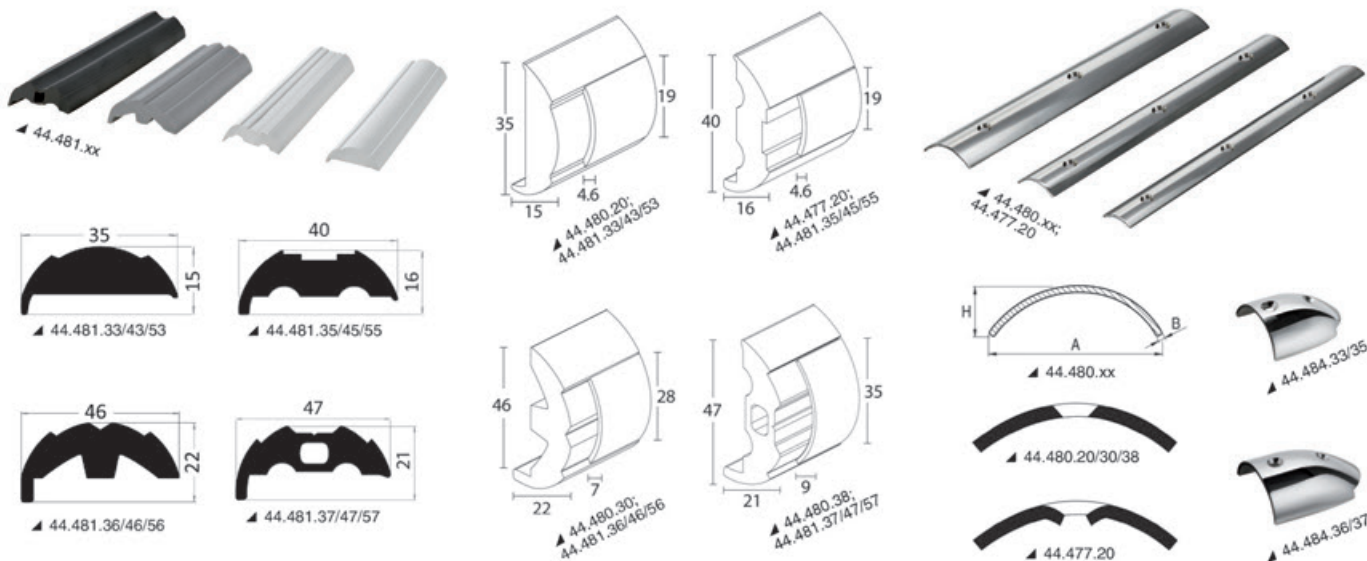

Steering wheel with stainless steel spikes

Mirror-polished stainless steel spikes and hub.

Code	Ø mm	Crown	Crown colour
45.125.03	350	Wood	Teak

Carbon pole for Bimini top

The pole rotates by 90° inside the bushing and locks. The poles are fitted with tightening bushings. Clamcleat for easy adjustment and tensioning of the Bimini top already mounted on the pole. Compatible with recess-fit bushings 46.815.xx and 46.820.xx. Fastening rope: eye spliced Dyneema rope. It can be used for direct installation on the Bimini top by means of a 10-mm Ø pawl or a snap hook.

Code	Ø mm	Height cm	Bulkhead stowage system OPTIONAL
46.816.07	38	185	34.358.38

46.817.00 MARLOW spliced line, length 130 cm with 50 cm adjustment



34.358.38

OSCULATI



46.817.00



Maxi fastening bushing



Tailored cover for MERCURY engines

Made to measure for the engine model. For storage in outdoor areas. Colour matches the engine (black).

For complete engine	Engine	HP	Year	Leg
46.550.49	V12 7,6L	600	2021>	25"
46.550.50	V12 7,6L	600	2021>	30"
46.550.51	V12 7,6L	600	2021>	35"

OCEANSOUTH



CYCLONE PROTECT™
PREMIUM WOVEN POLYESTER FABRIC
WITH NON WOVEN BACKING



Tailored cover for HONDA engines

Made to measure for the engine model. For storage in outdoor areas. Honda grey colour.

For complete engine	Engine	HP	Year	Leg
46.553.02	BF200D/225D/250D V6 3.6L	175/250	2011 >	25"
46.553.03	BF200D/225D/250D V6 3.6L	175/250	2011 >	30"

OCEANSOUTH

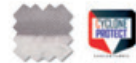

CYCLONE PROTECT™
PREMIUM WOVEN POLYESTER FABRIC
WITH NON WOVEN BACKING



Tailored cover for SUZUKI engines

Made to measure for the engine model. For storage in outdoor areas. Colour matches the engine (black).

For complete engine	Engine	HP	Year	Leg
46.552.14	4 cylinders 4T 2L	DF115BG/140BG	2021>	20"
46.552.16	4 cylinders 4T 2L	DF100/115/140A	2012>	25"

OCEANSOUTH



CYCLONE PROTECT™
PREMIUM WOVEN POLYESTER FABRIC
WITH NON WOVEN BACKING



Ergonomic padded seat with RM52 flip-up bolster

Rotary moulding plastic core. HD foam padding. Hole in the lumbar area.
Soft vinyl upholstery with a central diamond-shaped stitch texture with beige double seams.



Code	Type	Colour
48.410.20	Coated with high-quality vinyl	 Dark blue with beige seams
48.410.21	Only padding, ready to be coated	-

Available from October 2023

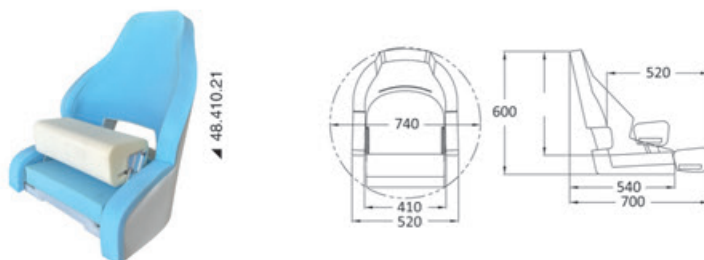

Double ergonomic padded seat with H99 flip-up bolster

Rotary moulding plastic core. HD foam padding. Hole in the lumbar area.



Code	Type	OPTIONAL slide rail
48.410.40	With padding, ready to be covered	48.715.00

Available from October 2023

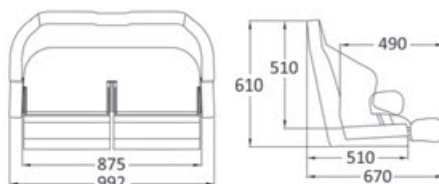

Twin slides for double seat

48.715.00 Twin slides in anodized aluminium to fasten double seats 48.410.40. Only one of the slides is fitted with release lever for an easier sliding movement.

Available from October 2023

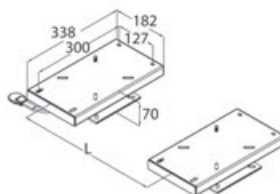
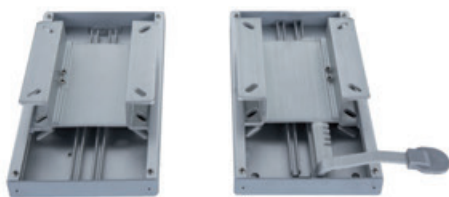

Pedestal with seat mount

Made of mirror-polished anodized aluminium, fitted with large diameter bases and thick tubes. It matches any seat frame.

Code	Height mm	Type	Table plate mm	Pedestal Ø mm	Base Ø mm	Base
48.703.58-R1	300/400	Telescopic	338x182	88/73	305	Polished
48.703.59-R1	350/470	Telescopic	338x182	88/73	305	Polished
48.703.60-R1	435/635	Telescopic	338x182	88/73	305	Polished



Thread Lock aluminium table pedestal

Made of anodized aluminium. The pedestal screws into the base by means of the ingenious and **extremely stable** Tread Lock system. Floor **recessless** mounting of the base onto the deck floor, overhang of as little as 20 mm.

Code	Height mm	Type	A/B/C Pedestal Ø mm	Version	Finish
48.417.60*	685	Fixed	60	Specific for table 48.417.50/51/52	Satin-finish
48.417.61*	500/700	Telescopic	60/50	Specific for table 48.417.50/51/52	Mirror-polished
48.417.63* New	450/700	Telescopic	73/60	Specific for table 48.417.50/51/52	Mirror-polished
48.417.67* New	450/775	Telescopic	73/60/50	Specific for table 48.417.50/51/52	Mirror-polished
48.417.64	689	Fixed	60	For generic tables	Satin-finish
48.417.65	500/700	Telescopic	60/50	For generic tables	Mirror-polished
48.417.66 New	450/700	Telescopic	73/60	For generic tables	Mirror-polished
48.417.68 New	450/775	Telescopic	73/60/50	For generic tables	Mirror-polished

* No upper base. Direct connection into the table recess.

48.417.62 OPTIONAL Only base for 48.417.xx. To be used as table pedestal in the cabin and in the cockpit.

Available from October 2023

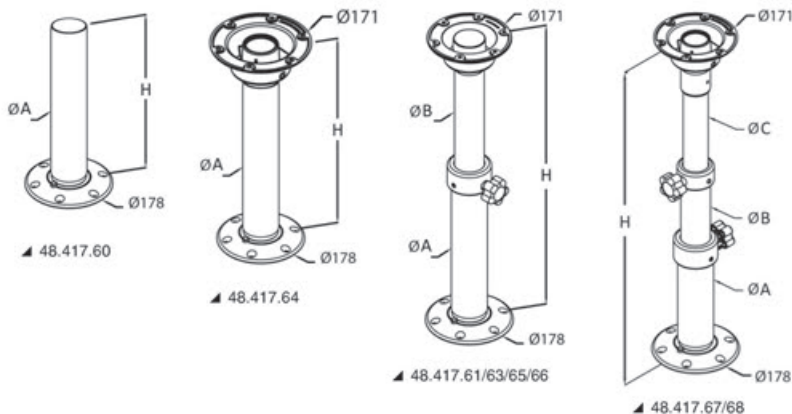

Giant Heavy Duty black table pedestal

Made of black anodized aluminium with black plastic fastening collars for a total black effect. Fitted with gas spring for upstroke, no need to bore the floor for downstroke. Tri-telescopic.

Code	Height mm	Extra-flat base Ø mm	Tube Ø mm	Table plate mm	OPTIONAL extension kit
48.720.04	345/714	305	100/88/72	305x305	48.724.01; 48.724.02

Available from November 2023

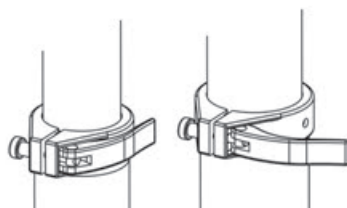

U Douglas Marine



Mini retractable ladder

AISI316

Compact built-in telescopic ladder with 3 steps + case to be integrated into the gangplank thickness. Ideal for smaller boats for its compact size. Made of mirror-polished stainless steel. Made in Italy by Douglas Marine. High-precision slip-in/out sliding movement.

Code	Steps	Length mm	Front plate mm	Casing mm	Type
49.549.63	3	889	307x88	250x460x53	Manual lock

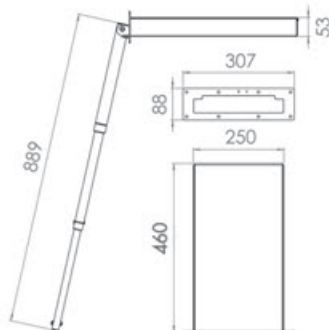

U Douglas Marine



EasyOne retractable ladder

AISI316

AUTOMATIC HANDLE

4-step recess-fit AISI316 stainless steel telescopic ladder. Fitted with built-in railing that automatically raises and lowers when you rotate the ladder. The railing closing system makes it easier to retrieve the ladder from the gangplank. The ladder has a guided pull-out system for better and more precise sliding.

Code	Steps	Length mm	Front plate mm	Casing mm	Type
49.570.04	4	1156/1367	455x112	395x550x73	Manual lock

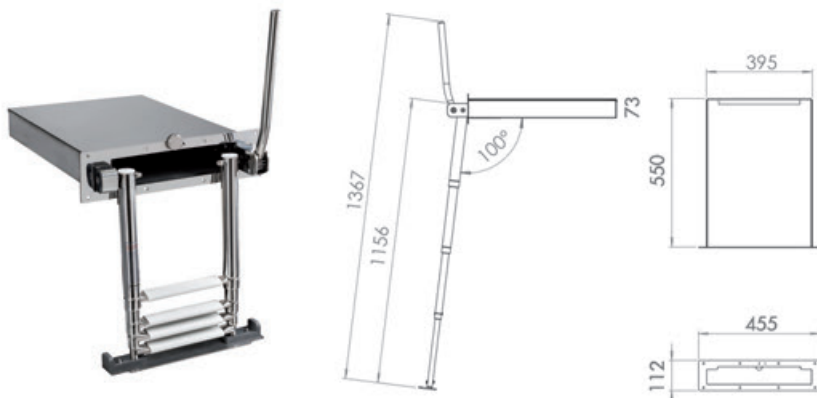

Square sink

White ceramic sink for surface mounting. Tap not included.

Code	AxBxC mm
50.189.11	400x300x130

50.186.97 Chromed brass drain. 75-mm long with push-pull closure and 1" 1/4 thread. Also used to fix the sink onto the flat rest surface.

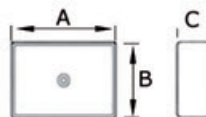

50.186.97
Optional



Universal removable pot holder set with flush base

50.707.00 The adjustable arms adapt to any type of pots and pans. Made of AISI316 stainless steel and PA6 nylon (V0 fire rating flame retardant plastic).
Flush base to be installed on hobs or 2- to 42-mm thick kitchen tops.

Available from December 2023

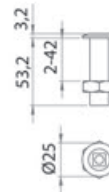
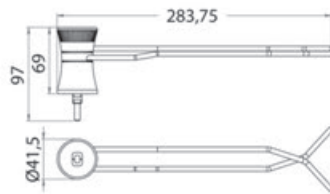

Touch control glass ceramic hob unit

30-cm glass ceramic cooktop, 2 x hi-ligh units, touch controls with 9 heating levels.
3.0 kW max current draw, glass ceramic resistant to high temperatures. Residual heat indicators, fast and easy cleaning.
Heat up technology: after choosing the max heating level, you can set a second level the system will switch to after reaching the max heating power for a preset period of time. This function is ideal to heat up soups while reducing the current draw.
All hob units are fitted with touch controls and child restraint system. At the touch of a key, all settings are reliably locked thus preventing any misuse.

Code	V	←→ mm		Burners W	Ignition
		outside	recess		
50.707.82	220	505x300	482x282	1800 - 1200	touch-control



4-burner glass ceramic hob unit

- 4 x hi-ligh units.
- 6.0 kW max current draw.
- Touch controls with 9 heating levels.
- High-radiance glass ceramic.
- Residual heat indicators.

After choosing the max heating level, you can set a second level the system will switch to after reaching the max heating power for a preset period of time. This function is ideal to heat up soups while reducing the current draw. All hob units are fitted with a child restraint system: at the touch of a key, all settings are reliably locked thus preventing any misuse.

Code	V	←→ mm		Burners W
		outside	recess	
50.707.73	220	580x505	560x490	2x1200 + 2x1800

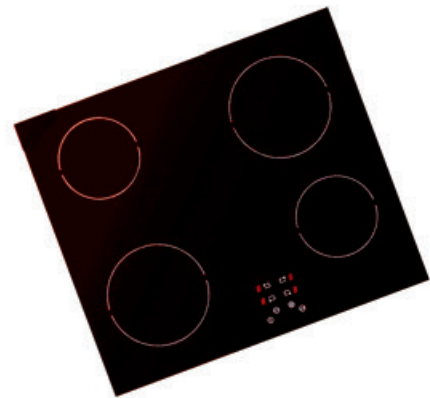
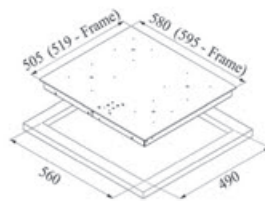

Satin-finish stainless steel electric barbecue

Stainless steel surface. Black enamel cast iron grid. Overheat prevention circuit.

Code	V	Power W	←→ mm	
			external	recess
50.709.09	220	2400	510x305	482x282

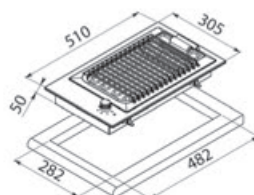

IGLOO® iceboxes



IGLOO rigid icebox (up to 100 litres)

Made with UV-resistant, high-efficiency thermal insulation materials. Designed for onboard use. Ideal for food and fish conservation as well as live bait well. Anti-odour plastic lining. Sturdy frame you can sit on.

Code	Volume l	Model	Drain plug	UV protection	Ice retention days*	←→ cm	kg	OPTIONAL cushions
50.558.33	23	MARINE ULTRA 25	No	Yes	3	52X27X33 H	3	-
50.558.16	28	MARINE ULTRA 30/3	No	Yes	3	43X27X44 H	3.6	-
50.558.26	66	MARINE ULTRA 70	Yes	Yes	5	76x42x41 H	6.2	50.566.80
50.558.24	94	MARINE ULTRA 100	Yes	Yes	5	88x43x47 H	9.1	-

* Days of ice retention at an external temperature of 32°C



Spares for IGLOO ice makers

Made of rugged and UV-resistant material. Supplied with fixing screws, easy to install.



Code	Type	Couleur	←→ cm	Compatible with
50.559.11	Plastic/SS lock	- -	-	50.558.54; 50.558.26; 50.558.24
50.559.16	ULTRA handles	White	13,28x2,51x14,3	50.558.54; 50.558.26
50.559.17	ULTRA handles	White	13,28x2,51x14,3	50.558.24

TECMA Silence Plus 2G electric toilet bowl

The Silence Plus is the 'big bowl' model. The length of 51 cm / 20.1 inches creates the at-home seating feeling.

Italian white ceramic, soft-close thermosetting polyester seat.

All in One control panel (50.226.50) included.

Fitted with solenoid to bypass the onboard plumbing. For installation with sea water inlet pump, order code 16.525.12 / 16.525.24 or similar.

Code	Model	V	mm			kg	Built-in bidet	Installation
			Height	Width	Depth			
50.227.07	Silence Plus 2G Short Deep Bowl	12	360	397	513	23.5	No	Under the floor
50.227.08	Silence Plus 2G Short Deep Bowl	24	360	397	513	23.5	No	Under the floor

All models can be ordered in ivory or black, and can have a built-in bidet function



▲ Built-in bidet



▲ Built-in bidet

Installation below the floor

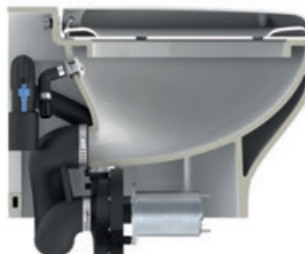

Floor installation



TECMA Elegance 2G electric toilet bowl

The Elegance 2G is the 'small bowl' model. The length of 43 cm maximizes comfort within reduced spaces onboard.

Italian white ceramic, soft-close thermosetting polyester seat.

All in One control panel (50.226.50) included.

Fitted with solenoid to bypass the onboard plumbing. For installation with sea water inlet pump, order code 16.525.12 / 16.525.24 or similar.

Code	Model	V	mm			kg	Installation
			height	width	depth		
50.227.24	Elegance 2G Short Deep Bowl	12	355	377	434	23.5	Under the floor
50.227.25	Elegance 2G Short Deep Bowl	24	355	377	434	23.5	Under the floor

All models can also be ordered in ivory or black with built-in bidet function.



▲ 50.226.50

Installation below the floor



Floor installation



CEM Sbr self-priming electric pump with bronze single screw

Consisting of a worm screw rotor revolving inside an NBR rubber stator. These electric pumps are used in the marine sector to drain waste boxes, toilet black waters and particularly viscous liquids with small suspended bodies.

Bronze pump body, AISI316 stainless steel shaft and rotor, AISI316 stainless steel and NBR joint, ceramic/graphite/NBR (anti-corrosion) mechanical seal.

24V permanent magnet motor, IP44 protection degree, F insulation class, continuous service S2 (40 minutes).



Code	Model	V	Flow l/min	Current draw A	Power		RPM	Max head m	kg
					HP	kW			
50.229.25	SBR	24	50	18	50	0.37	1400	40	12

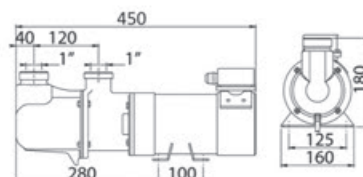

ULTRAFLEX hydraulic steering kits for outboard engines



▲ 45.282.00/01



▲ 45.282.03

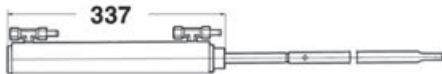

▲ 45.282.03

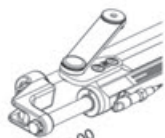
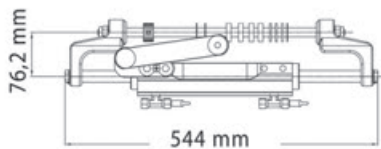

45.282.00

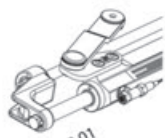

45.282.01

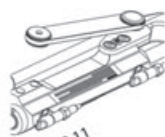

45.282.11

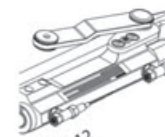

45.282.12

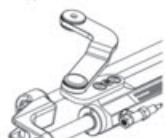

45.282.13

Hydraulic cylinder for outboard engines

Engine	Model	Year	Cylinder
MERCURY and MARINER	115-125-150 EFI 2S; 225-250 EFI 2S; 75-90-115 Optimax; 135-150-175 Optimax; 200-225-250 Optimax; Racing 300 Optimax; 100-115 EFI 4T; 250 Saltwater EFI 4S; 135-150-175-200 Verado L4; Fourstroke 175-200 V6; Fourstroke 225-300 V8	1990-2007; 2000-2007; 2004-now; 1999-now; 1999-now; 1999-2011; 2007-now; 2007-2011; 2004-now; 2018-now; 2018-now	UC128-OBF/1; UC128-OBF/1; UC128-OBF/3; UC128-OBF/1; UC128-OBF/1; UC128-OBF/1; UC128-OBF/1; UC128-OBF/1; UC128-OBF/1; UC128-OBF/1; UC128-OBF/1
ENVIRUDE	E75-E90 2S; E115-E130-E135 2S V4; E150-E175-E200-E225-E250-E300 2S V6	2004-now; 1995-now; 1995-now	UC128-OBF/2; UC128-OBF/2; UC128-OBF/2
YAMAHA	115C-130B 2S; 75C-90 2S; 115C-130B 2S; 150F-200F-250G 2S; 150 HPDI VMAX 2S; 175-200-225-250-300 HPDI VMAX 2S; F115-F150 EFI 4S; F200-F225-F250 4S; F70 4S; F115-F150-F175-F200 L4 4S; F200-F225-F250-F300 V6 4S	1990-2008; 1998-2008; 1990-2008; 1996-2007; 2000-2008; 2000-2008; 1997-2007; 2002-2007; 2010-now; 2004-now; 2004-now	UC128-OBF/2; UC128-OBF/2; UC128-OBF/2; UC128-OBF/2; UC128-OBF/2; UC128-OBF/2; UC128-OBF/1; UC128-OBF/2; UC128-OBF/1P; UC128-OBF/1; UC128-OBF/2
HONDA	BF75-BF90 4S; BF115-BF130 4S; BF135-BF150 4S; BF150 V-TEC 4S; BF175-BF200-BF225-BF250 4S	1995-now; 1998-now; 2005-now; 2008-now; 2001-now	UC128-OBF/1; UC128-OBF/3; UC128-OBF/1; UC128-OBF/1; UC128-OBF/1
SUZUKI	DF70-80-90 4T; DF100-115-140 4S*; DF100-115-140 4S; DF150-175-DF200 L4 4S; DF200-DF225-DF250-DF300-V6 4S	1998-now; 1998-2008; 1998-now; 2006-now 2004-now	UC128-OBF/2; UC128-OBF/1*; UC128-OBF/1; UC128-OBF/1; UC128-OBF/2
TOHATSU	115-120-140 2S; 70-90-115 TLDI 4S; BFT60-75-90 4S; BFT80-100-115 4S; BFT150-200-225-250 4S	2004-now; 2004-now; 2015-now; 2015-now; 2015-now	UC128-OBF/2; UC128-OBF/1; UC128-OBF/1; UC128-OBF/3; UC128-OBF/1
SELVA	80 Portofino/Tigershark 2S; 150 White Shark 2S; 100EFI Marlin - 115 EFI Narwhal-; 150EFI Killer Whale 4S	1995-2008; 2001-2007; 2000-now; 2000-now	UC128-OBF/1; UC128-OBF/2; UC128-OBF/1; UC128-OBF/1
JOHNSON	BJ90-115-140 4S; J90-115 V4 2S; J150-175 V6 2S; J200-225 V6 4S	2001-2007; 1995-2007; 1995-2007; 2004-2007	UC128-OBF/1; UC128-OBF/2; UC128-OBF/2; UC128-OBF/2

*NOTE: in case of Suzuki® models made from 1998 to 2008 (old model), cylinder UC128-OBF/1 shall be ordered along with adjustment KIT 45.419.54.

For higher power uses, we recommend the "high performance" SilverSteer™ cylinder.

Code	Mounting	Trimmed	Volume cc	Thrust kg	Stroke mm	Pipe joints	Type
45.282.00	front right	yes	120	450	185	3/8"	UC-128-OBF/1
45.282.01	front right	yes	120	450	185	3/8"	UC-128-OBF/2
45.282.11	front left	yes	120	450	185	3/8"	UC-128P OBF/1
45.282.12	front left	yes	120	450	185	3/8"	UC-128P OBF/2
45.282.14	New front	yes	120	450	185	3/8"	UC-128 OBF/3
45.282.03	side, non trimmed	no	132/163	455/563	203	3/8"	UC 132 OBS

Pair of SILVER STEER high-pressure hoses

Kit including a pair of high-resistance hoses reinforced with pre-crimped fittings and anti-crush reinforcing sleeves.

Code	Type	Length m
45.277.70	OB-SVS 70	7
45.277.80	OB-SVS 80	8



Double cylinder/double engine coupling kit for UC-130-SVS cylinders

Code	Engine centre distance mm	Hose length mm
45.278.01	660	381
45.278.02	686	407
45.278.03	711	432
45.278.04	724	445
45.278.05	737	457
45.278.06	762	483
45.278.07	777	496



SUZUKI DF100/115/140 coupling rod

45.156.33 For double engine/double cylinder. 660/950-mm engine centre distance.



Coupling rod for outboard engine with hydraulic steering

Double/triple engine, with brackets, UC128/UC130 cylinders. All parts made of stainless steel.

Code	Model	Cylinder type	Engines		Independent tilting	Engine centre distance mm
			N.	type		
45.156.25	A96-B29	Single	2	Suzuki/Honda	Yes	660-736
45.156.26	A96-B34-5	Single	2	Suzuki/Honda	Yes	736-873
45.156.27	A95-B32	Double	2	Suzuki/Honda	Yes	660-813
45.156.28	A95-B37-5	Double	2	Suzuki/Honda	Yes	813-952
45.156.29	A97-B30	Double	3	Suzuki/Honda	Yes	660-762
45.156.30	A97-B35-5	Double	3	Suzuki/Honda	Yes	762-901

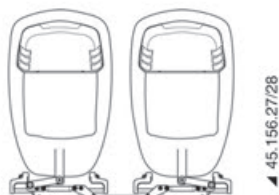
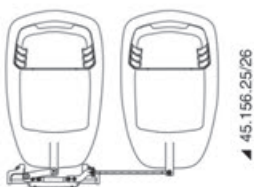
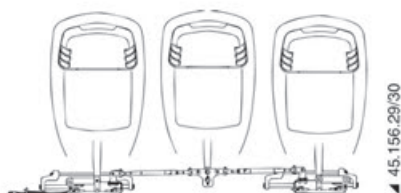

OSCOLATI



H2O / fuel tap plug for stainless steel, plastic and aluminium tanks

Made of nylon, fitted with a stainless steel tap plug elbow-shaped hose.
Easy to fix on any flat surface by boring a 5-cm hole.

Code	Version
52.199.02	Pipe Ø 12 mm, length 56 cm, bore Ø 50 mm
52.199.14	New Pipe Ø 14 mm, length 84 cm, bore Ø 50 mm



OSCOLATI



▲ 52.731.71



▲ 52.731.81

Fuel pipe

Made with a special co-extruded hose with polyester reinforcements; 8x13-mm cross section, resistant up to 15 bar; includes oversized pump, suitable for unleaded petrol.

Code	Version	Length m
52.731.71	With Honda terminal joint	2
52.731.81	With two Suzuki joints up to 140 HP 4 T	3



Air conditioning pipes

Flexible pipe made of additivated polyolefin film resins and spiral in a harmonic steel thread.
Anti-vapour internal protection made of additivated polyolefin resin. Thermal-barrier coating in polyester fibre.

- colour: black
- working temperature: -20/+90°C (+110°C peak)
- bending radius: 0,8-1,5xø
- air speed: max 20m/sec
- pressure: approx. max 200mm
- reaction to fire Class 1 (Ministerial Decree 26/06/84).



Code	←→		Flow rate (m3/h)		←→ roll package cm
	Ø mm	Length m	8m/s air speed	10m/s air speed	
50.265.10	102	10	250	333	23x23x78
50.265.12	127	10	383	368	23x23x78
50.265.15	152	10	575	773	23x23x78

SHURHOLD
CLEAN-N-SIMPLE

▲ 36.982.00



▲ 36.975.00

Scrubbers

Fitted with a **polyurethane lacquered marine wooden** structure, anti-shock corners, "fibre premium", **aluminium** clip-on connector; available in 2 different sizes.

Brush 10"	Brush 6"	Fiber	
		type	material
36.975.00	36.970.00	extra soft	blue nylon
36.982.00	36.965.00	soft + medium*	red polyester

- * Combination of soft external fibers for washing and more aggressive internal fibers to eliminate stubborn dirt or encrustations.

White gelcoat spray

SPRAY

Single-component gel coat for fast finish of fiberglass surfaces. It makes porous surfaces even and the result is a satin-finish in the colour applied.

Code	Package
65.520.11	400



Faux Teak self-adhesive teak-like EVA deck flooring

Self-adhesive mat for DIY flooring.
Stain-resistant and easy to clean even with a pressure washer.
Very good UV-resistance that preserves the colour.
Non-slip waterproof flooring material.
Blow-cushioning material.

Code	Colour	Thickness mm	←→ mm	Density kg/m ³	Adhesive
65.909.01	Wood	6	2400x1200	180	3M
65.909.02	Gray	6	2400x1200	180	3M



▲ 65.909.02



▲ 65.909.02



▲ 65.909.01

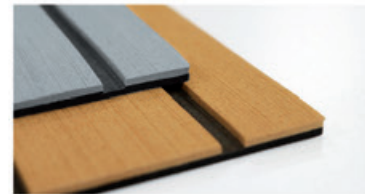

ECO-BACT H-Power fuel biocide

Bacterial pollution of diesel fuel is a serious and complex question that has increasingly developed in recent times. Differently from traditional diesel sludge (paraffin, carbonaceous residues and tar), that is fluidized by Fastol and then added back to the fuel, bacterial sludge is soluble only in acids. Some ppm of water is enough to develop bacteria. The residues of the bacteria colonies are mucilage, algae, moulds or filaments that increase rapidly and clog filters and pipes causing damage and even engine failures. Their proliferation also starts corrosion in the tank.

ECO-BACT H-Power is a **biocide whose active principle has been boosted**: it's as effective as the previous formula but **requires lower quantities and therefore the operating costs are much reduced**. It is soluble in both water and diesel, that concentrates in the aqueous phase of the diesel fuel where contamination concentrates.

ECO-BACT H-Power **decontaminates polluted fuel tanks** and can be used **periodically** to prevent contamination.



Code	Package	Treatment	
		continuous	periodical
65.049.02	1 l	1 l every 3000 l tank capacity (0.3 per thousand)	1 l every 5000 l tank capacity (0.2 per thousand)

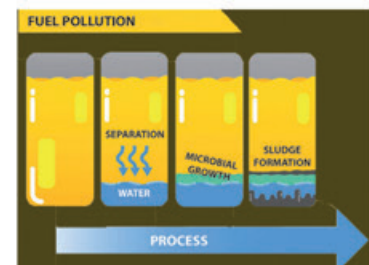

KING STARBOARD®



King StarBoard® sheets

The original marine-grade high-density polyethylene sheet.

The King name is synonymous with quality and the King StarBoard® brand has been helping pros build better boats for more than thirty-years.

It is the product of a proprietary process called K-Stran™, the most advanced manufacturing process for superior flatness and consistency. Matte finish on both sides of the sheet.

It is environmentally stabilized to withstand the harshest outdoor conditions. It will not rust, delaminate or rot when exposed to UV, humidity or water.

Possible applications:

- Structural roofing.
- Bulkheads in the bilge or the peaks.
- Shelves.
- Furniture.
- Frames and finishings.
- Hatches and doors.
- Handles and rails.
- Fishing rod holders and glass holders.
- Steps and Dock Boxes.
- Tray tables.

Code	Thickness mm	Dimension mm	Colour
65.908.00 New	9.5	800x1200	<input type="checkbox"/> White
65.908.01	12.5	800x1200	<input type="checkbox"/> White
65.908.02	19	800x1200	<input type="checkbox"/> White



Paint rollers

High-quality professional paint rollers, 100% Made in Italy.

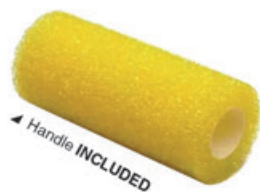

Code	Description	Ideal for	mm	Material	Handle	ORDER BY BOX	PACKAGE
65.653.12	Medium-grain sponge roller	MARLING GRIP anti-skid coating	200	Polyuret hane	INCLUDED	-	100

MARLIN Grip

Anti-slip, monocomponent, water-based antifouling coating. Atoxic, elastic, UV-resistant, ideal for deck applications. It creates a soft and smooth surface yet walking- and weather-resistant.

Easy to apply with a regular medium-to-large grain roller or with a textured finish roller.

The final texture depends on the **quantity** applied, on the **pressure** and on the **number** of layers.

Yield: 2/3 m²/litre (depending on the quantity applied).

To be diluted. Cleaning with water.



Code	Package I	Colour	Dedicated rollers (medium grain sponge)
65.119.01	1	<input type="checkbox"/> White	65.653.12
65.119.02	1	<input type="checkbox"/> Ivory	65.653.12
65.119.03	1	<input type="checkbox"/> Light grey	65.653.12

VA NX inflating valve

EASY MAINTENANCE

VA NX is smaller than other valves currently available on the market. Its main feature is that the valve body can be replaced without removing the external part glued to the inflatable (only the internal valve is replaced).

Code	Color	Fabric thickness mm	A mm	B mm	Bore Ø mm	Nominal flow l/min
66.446.35	Grey	0.5 - 3.5	69	42	43	2000
66.446.36	Black	0.5 - 3.5	69	42	43	2000
66.446.37	Chromed	0.5 - 3.5	69	42	43	2000
66.446.38	- Valve body only	-	-	-	-	-

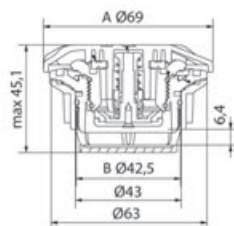

▲ 66.446.36



▲ 66.446.35



▲ 66.446.35



▲ 66.446.37



▲ 66.446.38

GE BTP-2 inflator

An evolution of the previous model, this inflator reaches a 1.2-bar (18 psi) pressure and is ideal for SUP boards.

Automatic stop when the preset pressure, adjustable by means of a pressure gauge, is reached. Fitted with hose and bayonet connector, universal fitting kit, 2.5-m power cable and battery terminal pliers.

It comes in a convenient and sturdy shoulder bag. Average inflating time: 9'30" (265-litre SUP @ 1250 mbar).

Code	Functions	V	W	Flow l/min	Max pressure	Current draw A	Dimensions	Weight kg
66.449.13	Inflation +deflation	12	240	120 - 420	1,2 bar (18PSI)	18	295x105x160 mm	2.5



STRIPSPEED paint stripper

Paint stripper for PROSPEED. No grinding or sand-papering when removing old PROSPEED.

It removes foul-release coatings from metal surfaces in 30 minutes or less. Easy to apply, non-flammable, non-caustic, it doesn't damage metal surfaces.

Code	Description	Paint for
65.893.01	1-l package	2 m ² surface to be treated
65.893.02	5-l package	10 m ² surface to be treated



ARC pulpit motor stand

Made-ready for pipe Ø 25 mm.

Code	Dimensions mm	Mounting
71.208.90	175x45x175	Preset for 25-mm Ø tubes
71.208.91 New	480x120-240x30	Preset for the use with 37.261.01/02



▲ 71.208.90



▲ 71.208.91



71.321.01



71.321.01



71.321.02



71.321.02



71.321.03



71.321.03

ARC Victor ultra-light folding chair

Structure in power coated light alloy, armrests in teak and back in batylene resistant to UV rays, sun, bad weather, etc.

Code	Colour	←→ cm		kg
		open	closed	
71.321.01	<input type="checkbox"/> White	50x57x89	50x22x70	-
71.321.02	<input type="checkbox"/> Grey	50x57x89	50x22x70	-
71.321.03	<input type="checkbox"/> Teak*	50x57x89	50x22x70	-

* Teak frame



71.320.01



71.320.03

ARC teak folding chair

Deluxe padded cushions and stainless steel zip fasteners.

Code	Colour	Finish	←→ cm		kg
			open	closed	
71.320.01	<input type="checkbox"/> Sand	Natural teak	50x57x89	50x22x70	-
71.320.03	<input type="checkbox"/> Navy Blue	Natural teak	50x57x89	50x22x70	-





71.374.04

ARC mug/cup holder

Code	Seats	←→ mm
71.374.04	4	20x22x15
71.374.06	6	29.5x22x15



71.374.06



ARC smartphone stand

Code	←→
71.327.13	Universal for all models

7 seas 5 continents 1 vision



1958 first store in Italy

1980 first export outside Europe

2023 delivering nautical supplies in 100 countries in the World

www.OSCVLATI.com



OSCOLATI GADGET and CLOTHING line

Promotional items will be sent by our sales department upon request. Please state the code of the item you wish to receive.

CLASSIC T-SHIRT



70.190.08-21MB

Crew neck short sleeve T-shirt.

Colour: blue.

Fabric: 100% cotton, 160 g.

Model: Unisex.

Available sizes: XS, S, M, L, XL, XXL, XXXL.

CLASSIC POLO SHIRT



70.190.01-21MB

Short sleeve two button polo shirt, side slits.

Ribbed collar and sleeves. Colour: blue with white inserts. Fabric: 100% cotton piquet, 190 g.

Model: Unisex.

Available sizes: XS, S, M, L, XL, XXL, XXXL.

SHOPPING BAG



70.199.15-01

Reusable shopping bag

made of H.D. 02 white, fold-over die cut bag. 70 My.

Dimensions: Ø 35x55x20 cm.

SHOPPING BAG WITH SHOULDER STRAP



70.199.21

Non-woven fabric shopping bag, 120 g., additional matt lamination and cardboard bottom.

Dimensions: 37x30x0.8 cm + shoulder strap 115x8 cm.

SPORT BLUE POLO SHIRT



MAN: 70.190.01-21MR

WOMAN: 70.190.01-21WR

Short sleeve two button polo shirt, side slits.

Red band under the collar. Ribbed collar and sleeves.

Fabric: 100% cotton piquet, 190 g.

Colour: blue with red inserts. Available sizes:

MAN XS, S, M, L, XL, XXL, XXXL.

Available sizes: WOMAN XS, S, M, L, XL, XXL.

SPORT WHITE POLO SHIRT



MAN: 70.190.01-21MW

WOMAN: 70.190.01-21WW

Short sleeve two button polo shirt, side slits.

Ribbed collar and sleeves.

Fabric: 100% cotton piquet, 190 g.

Colour: white with blue inserts. Available sizes:

MAN XS, S, M, L, XL, XXL, XXXL.

Available sizes: WOMAN XS, S, M, L, XL.

THERMAL CUP/ WATER BOTTLE

#BLUEPLANET



70.199.26-21MR

Made of SS, anti-slip rubber finishing. Keeps temperature up to 90 min.

Colour: red.

Capacity: 450 ml.

BADGE LANYARDS

70.199.20

Neck badge satin lanyard with standard shackle.

Colour: red. Dimensions: 2x47 cm.



KEYRING

70.199.16-210

Floating keyring.

Material: EVA 12 mm +

central support in white PVC.

White lanyard with 3 cylinders

(blue, white, red) in EVA + metal ring

Measures: 6x10 cm.



CLASSIC SWEATSHIRT



70.190.11-21MB

Full zip two pocket sweatshirt. Ribbed hem

and cuffs. Colour: blue with white inserts.

Fabric: 70% cotton 30% polyester, 330 g.

Model: Unisex.

Available sizes: XS,S,M,L,XL,XXL,XXXL.

CLASSIC SOFTSHELL



70.199.40

Three pocket softshell.

Colour: blue with white and red inserts.

Fabric: 310 g.

Model: Unisex.

Available sizes: XS,S,M,L,XL,XXL,XXXL.

FLAG

Print with perimeter stitching and two laces on the two corners. Material: 115 gr windproof nautical cloth.

70.199.23: Rectangular (100x150)

70.199.23-04: Rectangular (220x150)

Sublimatic printing, complete with

rod, round steel base and bag.

Outdoors and indoors. Material:

Windproof nautical towel 110 gr.

70.199.23-01

Small drop (95,7x216,5 cm)

70.199.23-02

Large drop (122,9x301,3 cm)

70.199.23-03

Large sail (91,2x346 cm)



CLASSIC CAP



70.190.04-21B

Cap with DRY-TECH inner lining, suitable for

outdoor sports. Pre-curved brim and

embroidered eyelets. Closure: velcro and

PVC strip. Colour: blue. Fabric: UPF50+,

75% nylon, 20% cotton, 5% elastan

Model: Unisex. One size fits all

SPORT CAP



70.190.04-21W

Cap with pre-curved brim, embroidered

eyelets and eyelet for lanyard attachment.

Closure: velcro.

Colour: white with blue and red inserts.

Fabric: 100% cotton. Model: Unisex.

One size fits all

STICKERS



70.199.12-01 (20x16 cm) 2 pc

70.199.12-02 (40x4,2 cm) 2 pc

70.199.19 (corner 45x42 cm) 1 pc

PVC sticker with Osculati logo.

BALL PEN



70.199.25-21BR

Metal ball point with blue or red

refill and touch pen tip. Sold in

the two colours

depending on availability.

Dimensions: Ø 8x142 mm.



POWER PLUG AND SOCKET

CRUISER



The plug has an ergonomic grip design and the rotating ring fastens it tightly to the onboard socket with a watertight closure while the rubber cover ensures an IP44 rating protection when not connected.

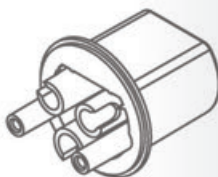

Sail in a sea of accessories



Extensive documentation

14,000 downloadable files (interactive 3D models, instructions, certificates and technical specifications)



Price lists

Check your reserved price list in real time



Excel-compatible

Copy/paste your orders from Excel and export your cart in a click



Your history

Check your order history at all times, online and offline



Replacement Items

Is an item discontinued? We suggest the optimal alternative for your needs



Online support

Contact our WhatsApp / Telegram support service for advice and solutions



Best price

We always suggest the recommended quantity at the lowest price

** Only for professional customers*

 **NEW OUTLET SECTION!**

Discover thousands of items at discounted prices up to 40%*

The preferential channel for your orders



Osculati S.r.l.

Via Pacinotti 12 - 20054 Segrate (Milano)
Tel.: +39 02.2699.111 - info@osculati.it

www.OSCULATI.com



IT AEO-F 23 2010



Reference 70.199.05EN

